

LEDVANCE LUMINAIRES POST TOP OPTI-SELECT



LEDVANCE LUMINAIRE SPECIFICATION DATA

Catalog #	Comments
Project	
Type	
Prepared by	

VALUE CLASS™



CERTIFICATIONS & LISTINGS

- cULus listed to UL1598 and CSA 22.2 no. 250 standards
- RoHS Compliant
- FCC Compliant
- ICES-005 Compliant
- IP65 Rated
- Wet Location
- IK08
- DLC Premium
- DarkSky Approved*
- TAA Compliant

AMBIENT OPERATING TEMPERATURE

- -40°F to +122°F (-40°C to +50°C)

ELECTRICAL

- Input voltage: 120–347V
- 0–10V dimming, down to 10%
- Surge Protection: 6 kV
- Power Factor: ≥0.9
- THD: ≤20%

RATED LIFE

- 100,000 hours (L₇₀) @77°F/25°C

OPTI-SELECT

Multiple distributions adjustable via switch, no lens swap needed and no screws to remove. Types 3, 4, and 5 in the same product.

SELECTABLE CCT

3000/4000/5000K or the exclusive 1800/2200/2700K (only 1800/2200/2700K is DarkSky Approved)

SELECTABLE WATTAGE

50/80/100/130W | 7,500/12,000/15,000/19,500 lm @4000K

UP TO 150 LPW

DE-AMBER TURTLE FRIENDLY VERSION

Suitable for coastal areas to minimize impact on sea turtles

INTEGRATED PHOTOCELL

That can be disabled in the field

CONTROLS READY AND OPTIONAL LEDVANCE LINK™ LUMINAIRE LEVEL LIGHTING CONTROL (LLC)

No wiring required

DURABLE FINISH

Resistant to 1,000-hour salt spray testing for superior corrosion protection. Available in bronze, black, white, or gray.

STANDARD POST TOP MOUNT

For 2-3/8" tenons and 3" poles, with optional wall/pole, pendant, or surface mount

INCLUDED ACCESSORIES

Post Top Mount and sleeve for 2-3/8" tenons or 3" poles

DESCRIPTION

The POST TOP OPTI-SELECT offers sleek, modern design paired with outstanding versatility. Featuring adjustable OPTI-SELECT distributions (Types 3, 4, and 5), selectable CCT and wattage, integrated photocell, and controls ready, it's perfect for pathways, parks, campuses, and pedestrian areas. Plus, a de-amber turtle-friendly version is available for sensitive coastal environments. Backed by a 5-year warranty, it delivers reliable performance and style wherever outdoor lighting is needed.

APPLICATIONS

- Walkways
- Pathways
- Pedestrian zones
- Public squares
- Parks
- Campuses
- Parking lots
- Roadways

WARRANTY

- 5-Year
- NLB Trusted Warranty Program



ORDERING GUIDE

STANDARD PRODUCTS										
POSTTOP	V	XXX	UNH	D	8	XXX	XX	XX	XX	X
PRODUCT NAME	SEGMENTATION	WATTAGE	VOLTAGE	DIMMING	CRI	COLOR TEMPERATURE	DISTRIBUTION	MOUNTING	FINISH	OPTIONS
POSTTOP = Post Top Luminaire	V = Value Class	S130 = 50/80/100/130W	UNH = 120-347V	D = 0-10V Dimmable	8 = ≥ 80	SC2 = 3000/4000/5000K	ADJ = Adjustable T3/T4/T5	WM = Wall/ Pole Mount CM = Ceiling Mount PM = Pendant Mount	BZ = Bronze BL = Black WH = White GR = Gray	P = Photocell D = Sensor*

*All models with a D are LLLC (Luminaire Level Lighting Control)

DarkSky APPROVED PRODUCTS										
POSTTOP	V	XXX	UNH	D	8	XXX	XX	XX	XX	X
PRODUCT NAME	SEGMENTATION	WATTAGE	VOLTAGE	DIMMING	CRI	COLOR TEMPERATURE	DISTRIBUTION	FINISH	OPTIONS	
POSTTOP = Post Top Luminaire	V = Value Class	S130 = 50/80/100/130W S050 = 50W	UNH = 120-347V	D = 0-10V Dimmable	8 = ≥ 80	SC15 = 1800/2200/2700K AMB = de-Amber	ADJ = Adjustable T3/T4/T5 T5 = Type 5	BZ = Bronze BL = Black WH = White GR = Gray	P = Photocell D = Sensor	

ORDERING INFORMATION

ITEM #	ORDERING ABBREVIATION	WATTAGE (W)	INPUT VOLTAGE (V)	CCT (K)	DISTRIBUTION	TOTAL LUMENS (LM)	LPW	BUG RATING	FINISH	MTO*	DLC ID # PREMIUM
STANDARD PRODUCTS											
66964	POSTTOPVS130UNHD8SC2ADJBZP	50/80/100/130	120-347	3000/4000/5000	T3/T4/T5	7,500/12,000/15,000/19,500	150		Bronze	-	S-14MKWN
66965	POSTTOPVS130UNHD8SC2ADJBLP	50/80/100/130	120-347	3000/4000/5000	T3/T4/T5	7,500/12,000/15,000/19,500	150		Black	-	S-14MKWN
66966	POSTTOPVS130UNHD8SC2ADJWHP	50/80/100/130	120-347	3000/4000/5000	T3/T4/T5	7,500/12,000/15,000/19,500	150		White	-	S-14MKWN
66967	POSTTOPVS130UNHD8SC2ADJGRP	50/80/100/130	120-347	3000/4000/5000	T3/T4/T5	7,500/12,000/15,000/19,500	150		Gray	✓	S-14MKWN
67346	POSTTOPVS130UNHD8SC2ADJWMBZP	50/80/100/130	120-347	3000/4000/5000	T3/T4/T5	7,500/12,000/15,000/19,500	150		Bronze	✓	S-14MKWN
67347	POSTTOPVS130UNHD8SC2ADJCMBZP	50/80/100/130	120-347	3000/4000/5000	T3/T4/T5	7,500/12,000/15,000/19,500	150		Bronze	✓	S-14MKWN
67348	POSTTOPVS130UNHD8SC2ADJPMBZP	50/80/100/130	120-347	3000/4000/5000	T3/T4/T5	7,500/12,000/15,000/19,500	150		Bronze	✓	S-14MKWN
67935	POSTTOPVS130UNHD8SC2ADJWMMWHP	50/80/100/130	120-347	3000/4000/5000	T3/T4/T5	7,500/12,000/15,000/19,500	150	B4-U0-G4 (T3/T4) B4-U0-G2 (T5) @3000K	White	✓	S-14MKWN
67936	POSTTOPVS130UNHD8SC2ADJCMWHP	50/80/100/130	120-347	3000/4000/5000	T3/T4/T5	7,500/12,000/15,000/19,500	150		White	✓	S-14MKWN
67937	POSTTOPVS130UNHD8SC2ADJPMWHP	50/80/100/130	120-347	3000/4000/5000	T3/T4/T5	7,500/12,000/15,000/19,500	150		White	✓	S-14MKWN
67938	POSTTOPVS130UNHD8SC2ADJPMWBLP	50/80/100/130	120-347	3000/4000/5000	T3/T4/T5	7,500/12,000/15,000/19,500	150		Black	✓	S-14MKWN
67939	POSTTOPVS130UNHD8SC2ADJCMBLP	50/80/100/130	120-347	3000/4000/5000	T3/T4/T5	7,500/12,000/15,000/19,500	150		Black	✓	S-14MKWN
67940	POSTTOPVS130UNHD8SC2ADJPMBLP	50/80/100/130	120-347	3000/4000/5000	T3/T4/T5	7,500/12,000/15,000/19,500	150		Black	✓	S-14MKWN
67941	POSTTOPVS130UNHD8SC2ADJWMMGRP	50/80/100/130	120-347	3000/4000/5000	T3/T4/T5	7,500/12,000/15,000/19,500	150		Gray	✓	S-14MKWN
67942	POSTTOPVS130UNHD8SC2ADJCMGRP	50/80/100/130	120-347	3000/4000/5000	T3/T4/T5	7,500/12,000/15,000/19,500	150		Gray	✓	S-14MKWN
67943	POSTTOPVS130UNHD8SC2ADJPMGRP	50/80/100/130	120-347	3000/4000/5000	T3/T4/T5	7,500/12,000/15,000/19,500	150		Gray	✓	S-14MKWN
DarkSky APPROVED PRODUCTS											
66968	POSTTOPVS130UNHD8SC15ADJBZP	50/80/100/130	120-347	1800/2200/2700	T3/T4/T5	6,250/10,000/12,500/16,250	125	B3-U0-G3 (T3) B4-U0-G4 (T4) B4-U0-G2 (T5) @2200K	Bronze	-	-
66969	POSTTOPVS130UNHD8SC15ADJBLP	50/80/100/130	120-347	1800/2200/2700	T3/T4/T5	6,250/10,000/12,500/16,250	125		Black	-	-
66970	POSTTOPVS130UNHD8SC15ADJWHP	50/80/100/130	120-347	1800/2200/2700	T3/T4/T5	6,250/10,000/12,500/16,250	125		White	✓	-
66971	POSTTOPVS130UNHD8SC15ADJGRP	50/80/100/130	120-347	1800/2200/2700	T3/T4/T5	6,250/10,000/12,500/16,250	125		Gray	✓	-
67116	POSTTOPV050UNHDAMBT5BZ	50	120-347	de-Amber	T5	870	17	B1-U0-G0	Bronze	-	-
67117	POSTTOPV050UNHDAMBT5BL	50	120-347	de-Amber	T5	870	17		Black	✓	-
67118	POSTTOPV050UNHDAMBT5WH	50	120-347	de-Amber	T5	870	17		White	✓	-
67119	POSTTOPV050UNHDAMBT5GR	50	120-347	de-Amber	T5	870	17		Gray	✓	-

*Made to Order

67346 WALL/POLE MOUNT



WALL MOUNTING

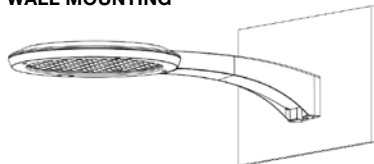

ROUND POLE MOUNTING

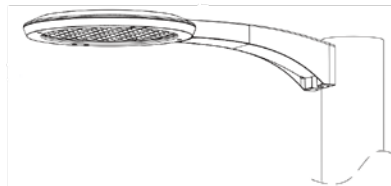

SQUARE POLE MOUNTING

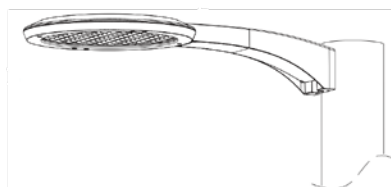

67347 CEILING MOUNT



67348 PENDANT MOUNT



INSTALLATION

Standard product: Post Top Mount compatible with 2-3/8" tenon and 3" pole. Other available mountings: surface, wall/pole, pendant and side arm mount.



INSTALLATION
GUIDE



DE-AMBER
VERSION



BRACKETS

Factory settings: SC2: 130W, 3000K, T5 | SC15: 130W, 2200K, T5

PHYSICAL INFORMATION

DESCRIPTION	DIAMETER IN (MM)	HEIGHT IN (MM)	WEIGHT LB (KG)	EPA
Post Top	18" (457 mm)	24.9" (632 mm)	14.3 lb (6.5 kg)	0.34

DIMENSIONS

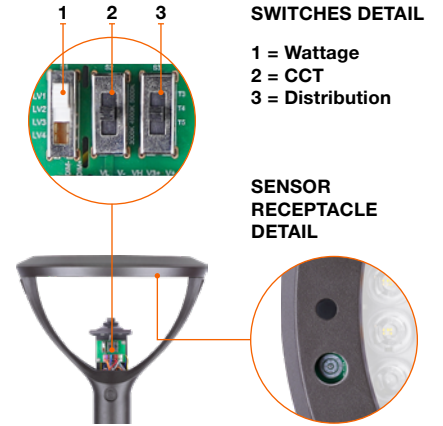
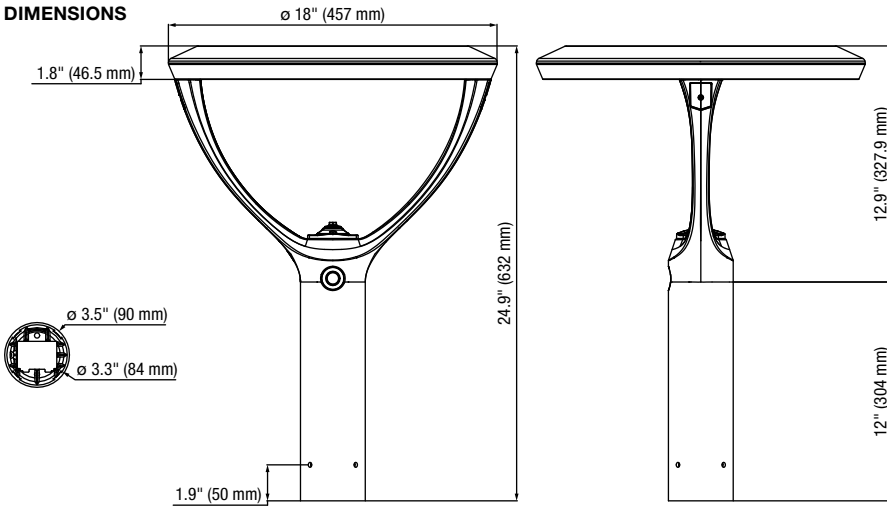

FINISH

COLOR	RAL#
Bronze	RAL#8019
Black	RAL#9011
White	RAL#9016
Gray	RAL#7045

OPTIONAL ACCESSORIES

ITEM #	ORDERING ABBREVIATION	ITEM DESCRIPTION
GLARE SHIELDS		
67078	POSTTOPVGLSBZ	Glare shield for Post Top, Bronze
67079	POSTTOPVGLSBL	Glare shield for Post Top, Black
67080	POSTTOPVGLSWH	Glare shield for Post Top, White
67081	POSTTOPVGLSGR	Glare shield for Post Top, Gray





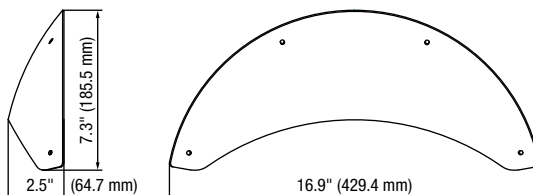

GLARE SHIELD



GLARE SHIELD INSTALLED*



CONTROLS ACCESSORIES

ITEM #	ORDERING ABBREVIATION	ITEM DESCRIPTION	
STANDALONE CONTROLS			
62664	HIGHBAYPIRMOTIONDAYSENSOR2	Field installable PIR Motion/Daylight Sensor, IP65, Max. mounting height 39 ft, White	
65622	HIGHBAYMOTIONDAYSENSOR	Field installable Microwave Motion/Daylight Sensor, IP65, Max. mounting height 49 ft, White	
65623	REMOTE/MOTIONDAY/001	Remote Control for Motion/Daylight Sensors—Remote is required to change default settings	
NETWORKED LIGHTING CONTROLS			
75913	SENSOR2ODPIR3.5BLEBLK	Outdoor Bluetooth® Low Energy Mesh PIR Sensor with Controller, Screw-in Plug & Play, 3.5 mm AUX, Black	
75944	ADAPTER3P3.5SCBK	LINK™ 3-PIN to 3.5 mm Adapter, Black	

*The glare shield must not be installed on the same side as the sensors

WATTAGE COMPARISON

LED SOURCE (W / LM)	REPLACES TRADITIONAL SYSTEM SOURCE	ENERGY SAVINGS
130W/19,500 lm	MH/HPS up to 400W	68%

DIMMER COMPATIBILITY

MAKE	DIMMER TYPE	MODEL
Leviton	0-10V	DS710
Leviton	0-10V	IP710
Lutron	0-10V	NTSTV-DV
Lutron	0-10V	NFTV
Lutron	0-10V	DVTV
Lutron	0-10V	DVSTV
Legrand	0-10V	H4FBL3PW

PHOTOMETRIC INFORMATION

HORIZONTAL ISO FOOT-CANDLE PLOT

130W luminaire, T3 distribution, mounted at 20' height

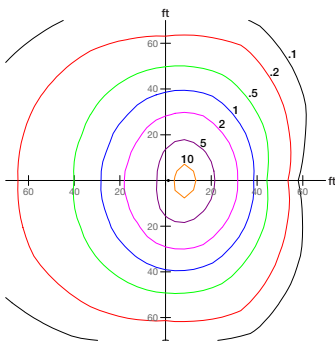

130W luminaire, T4 distribution, mounted at 20' height

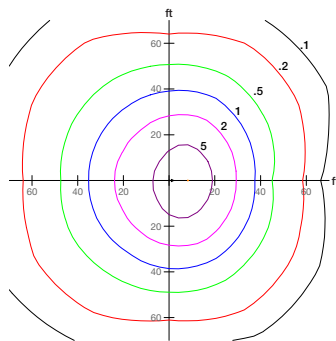

130W luminaire, T5 distribution, mounted at 20' height

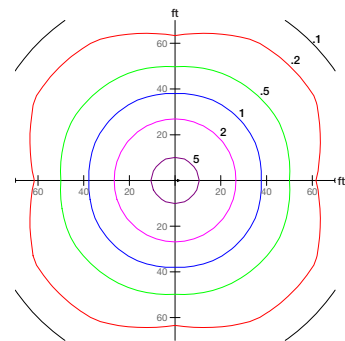

LEDVANCE LLC—North America
 181 Ballardvale Street, Suite 203
 Wilmington, MA 01887 USA
 Phone: 1-800-544-4828
 LEDVANCE.COM/EN-US

LEDVANCE LLC—Canada
 5450 Explorer Drive, Suite 100
 Mississauga, Ontario L4W 5N1
 Phone: 1-905-361-9333

LEDVANCE is a registered trademark.
 The Bluetooth® word mark and logos are registered trademarks owned by the Bluetooth SIG, Inc. and any use of such marks by LEDVANCE LLC is under license. All other trademarks are those of their respective owners. Specifications subject to change without notice.
 © 2026 LEDVANCE LLC