

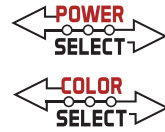

# XFIT



## KT-WPLEDXXPS-X4-8CSB-VDIM

### TRADITIONAL-SLIM LED WALL PACK

#### DESCRIPTION

Traditional-Slim LED Wall Pack | Power Select | Color Select | 120-277V Input | Medium or Large Housing | Bronze Finish | Glass Lens

#### APPLICATION

Building mount for exterior illumination (perimeters, pathways, loading docks, and other general security lighting requirements)



**10 YEAR**  
LIMITED WARRANTY

#### PRODUCT FEATURES

- Keystone Power Select technology (see Performance Specifications for details)
- Keystone Color Select technology (3000/4000/5000K)
- Slim, low profile design that matches footprint and distribution of legacy HID wall packs. Optimized for one-for-one replacements
- Heavy-duty die-cast aluminum housing with (5) 1/2" threaded conduit hubs: (1) on back and (1) on all four sides
- Powered by Keystone 0-10V dimming LED drivers
- Built-in dusk-to-dawn photocell behind translucent 3/4" threaded plug with anti-yellowing agent
- Borosilicate glass lens diffuses light source and provides uniform distribution
- Covers footprint of mid-size HID wallpacks
- Ambient operating temperature: -40°C/-40°F to 50°C/122°F
- UL Certified for wet locations; IP65 rated
- Fixture impact rating IK06
- Power Factor: > 0.95
- THD: < 20%
- LED chip lifetime: L70 > 100,000 hrs @ 25°C/77°F ambient fixture temperature
- Meets FCC Part 15, Part B, Class A standards for conducted and radiated emissions
- TAA options available. See *Ordering Information* below for details

#### PRODUCT IMAGES



KT-WPLED35PS-M4-8CSB-VDIM  
KT-WPLED55PS-M4-8CSB-VDIM  
KT-WPLED80PS-M4-8CSB-VDIM



KT-WPLED120PS-L4-8CSB-VDIM

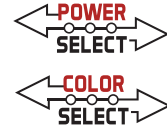

# KT-WPLEDXXPS-X4-8CSB-VDIM

## TRADITIONAL-SLIM LED WALL PACK

### PRODUCT SPECIFICATIONS

Catalog Number	Wattage	CCT	Lumens	Efficacy	Input Voltage	Dimming	CRI	Photocell	Legacy Equivalent
KT-WPLED35PS-M4-8CSB-VDIM	35W	3000K	4550	130 lm/W	120-277V	0-10V	> 80	Included	175W MH
		4000K	4655	133 lm/W					
		5000K	4620	132 lm/W					
	25W	3000K	3400	136 lm/W					
		4000K	3525	141 lm/W					
		5000K	3475	139 lm/W					
	15W	3000K	2100	140 lm/W					
		4000K	2160	144 lm/W					
		5000K	2160	144 lm/W					
KT-WPLED55PS-M4-8CSB-VDIM	55W	3000K	7260	132 lm/W	120-277V	0-10V	> 80	Included	250W MH
		4000K	7645	139 lm/W					
		5000K	7370	134 lm/W					
	45W	3000K	6120	136 lm/W					
		4000K	6435	143 lm/W					
		5000K	6255	139 lm/W					
	35W	3000K	4900	140 lm/W					
		4000K	5075	145 lm/W					
		5000K	5005	143 lm/W					
KT-WPLED80PS-M4-8CSB-VDIM	80W	3000K	10560 lm	132 lm/W	120-277V	0-10V	> 80	Included	320W MH
		4000K	11280 lm	141 lm/W					
		5000K	10960 lm	137 lm/W					
	70W	3000K	9380 lm	134 lm/W					
		4000K	10010 lm	143 lm/W					
		5000K	9800 lm	140 lm/W					
	55W	3000K	7645 lm	139 lm/W					
		4000K	8030 lm	146 lm/W					
		5000K	7975 lm	145 lm/W					
KT-WPLED120PS-L4-8CSB-VDIM	120W	3000K	17040	142 lm/W	120-277V	0-10V	> 80	Included	400W MH
		4000K	17640	147 lm/W					
		5000K	16920	141 lm/W					
	100W	3000K	13900	139 lm/W					
		4000K	14300	143 lm/W					
		5000K	13900	139 lm/W					
	80W	3000K	11280	141 lm/W					
		4000K	11520	144 lm/W					
		5000K	11440	143 lm/W					

\* Color Uniformity: CCT (Correlated Color Temperature) range as per guidelines outlined in ANSI C78.377-2017

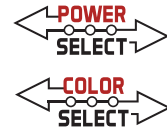

# KT-WPLEDXXPS-X4-8CSB-VDIM

TRADITIONAL-SLIM LED WALL PACK

## PHYSICAL SPECIFICATIONS

- KT-WPLED35PS-M4-8CSB-VDIM
- KT-WPLED55PS-M4-8CSB-VDIM
- KT-WPLED80PS-M4-8CSB-VDIM

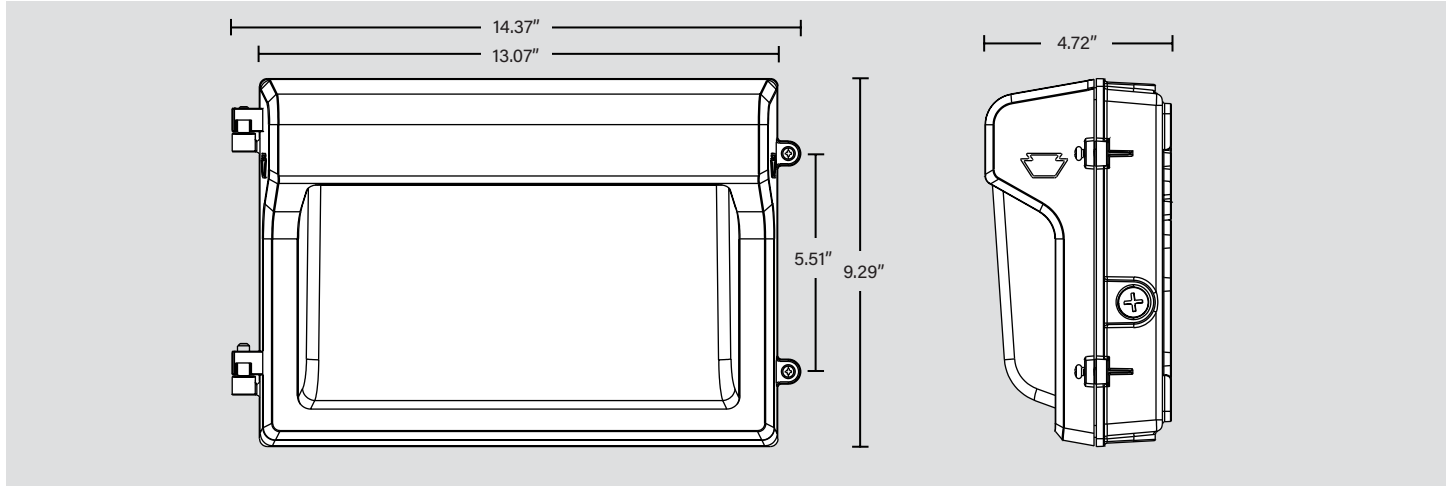

## KT-WPLED120PS-L4-8CSB-VDIM

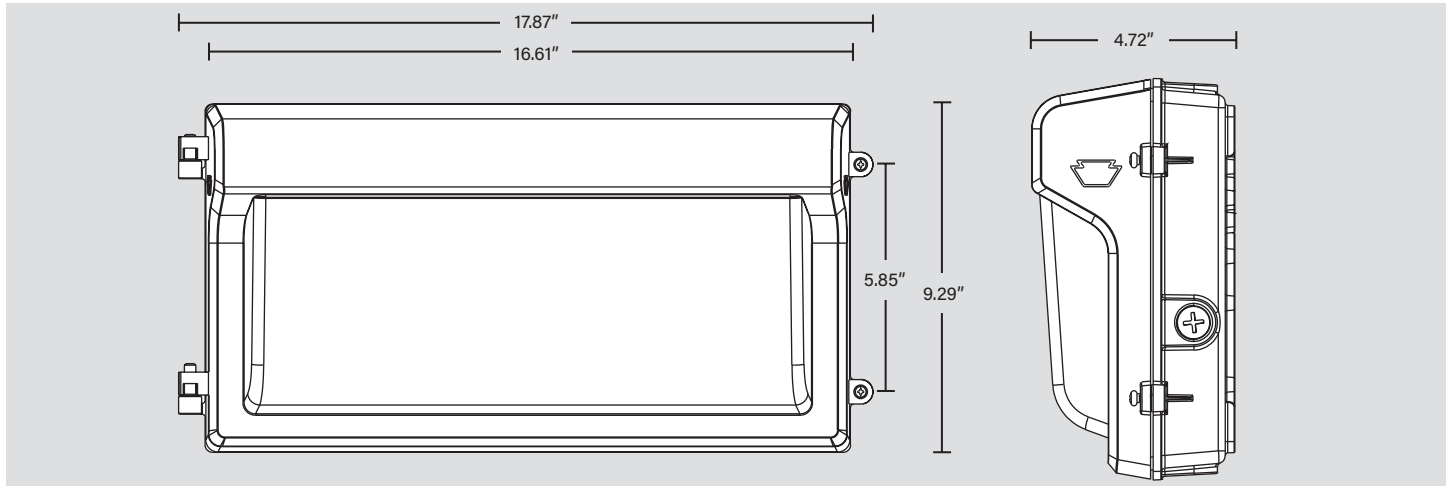

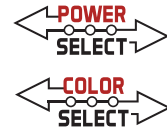

# KT-WPLEDXXPS-X4-8CSB-VDIM

## TRADITIONAL-SLIM LED WALL PACK

### GENERAL SETUP INSTRUCTIONS

#### GENERAL WIRING DIAGRAM

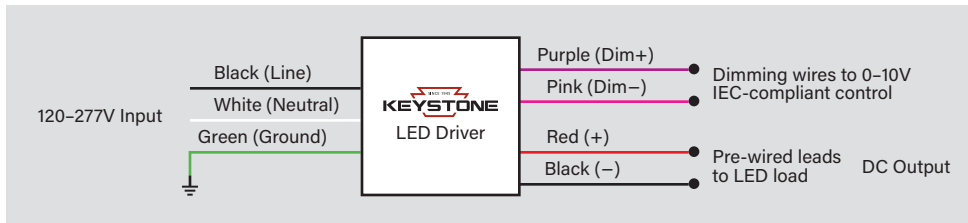

**Caution:** Before installing, make certain that AC power to the fixture is off.

**Caution:** The electrical rating of this product is 120-277V. Installer must confirm that there is 120-277V at the fixture before installation.

#### PHOTOCELL ENABLE / DISABLE

This fixture is equipped with a dusk-to-dawn photocell behind the translucent knock-out (KO) cover. Adjust the dip switch to enable (ON) or disable (OFF) the photocell function (see illustrations to the right). Fixture comes pre-set with photocell enabled unless otherwise noted.

#### COLOR SELECT (CCT) ADJUSTMENT

This fixture is equipped with Color Select technology. There is an adjustable dip switch behind the translucent knock-out (KO) cover to change CCT between 5000K, 4000K, and 3000K (see illustrations to the right). Fixture comes preset at 5000K unless otherwise noted.

#### POWER SELECT (WATTAGE) ADJUSTMENT

The Power Select dial for this fixture is located inside of the housing. To access the dial, open the fixture face (see below instructions for reference). This wall pack is selectable between 3 wattage options, and is preset to the highest option. Please see chart below for details.

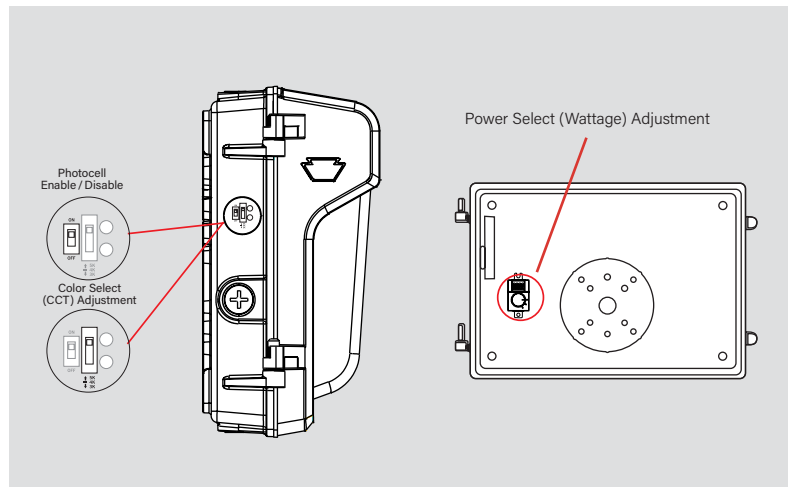

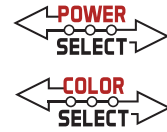

# KT-WPLEDXXPS-X4-8CSB-VDIM

## TRADITIONAL-SLIM LED WALL PACK

### PHOTOMETRIC SPECIFICATIONS

KT-WPLED35PS-M4-8CSB-VDIM

#### ISOCANDELA PLOT

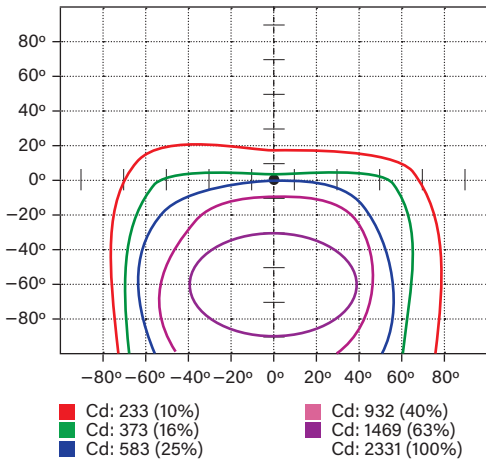

#### LUMINOUS INTENSITY DISTRIBUTION

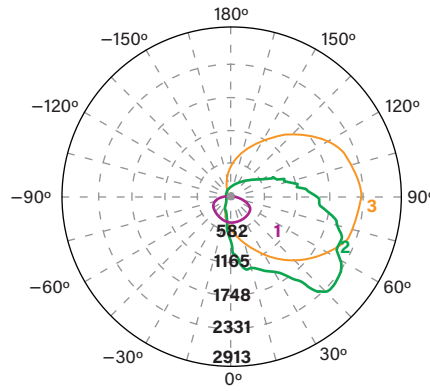

Average diffuse angle (50%): 121.6°

- 1 Violet C0 - C180
- 2 Green C90 - C270
- 3 Orange G48

Unit: cd

#### FLUX DISTRIBUTION

Zone	Lumens	% Luminaire
<b>Forward Light</b>	3,645 lm	81.6%
0°-30°	411 lm	9.2%
30°-60°	1,584 lm	35.4%
60°-80°	1,220 lm	27.3%
80°-90°	429 lm	9.6%
<b>Back Light</b>	216 lm	4.8%
0°-30°	78 lm	1.7%
30°-60°	84 lm	1.9%
60°-80°	43 lm	1.0%
80°-90°	11 lm	0.2%
<b>Up Light</b>	609 lm	13.6%
90°-100°	290 lm	6.5%
100°-180°	319 lm	7.1%

#### BUG\* Rating

##### Asymmetrical Luminaire Types

Type I, II, III, IV B0 U5 G3

##### Quadrilateral Symmetrical Luminaire Types

Type V, Area Light B0 U5 G3

\* Backlight, Uplight, Glare

#### MOUNTING

Side view

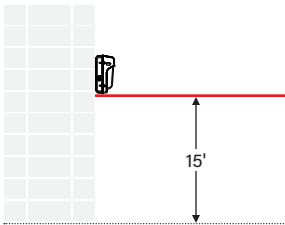

#### LIGHT DISTRIBUTION PATTERN

Isometric view from above; Luminaire mounted at 15'

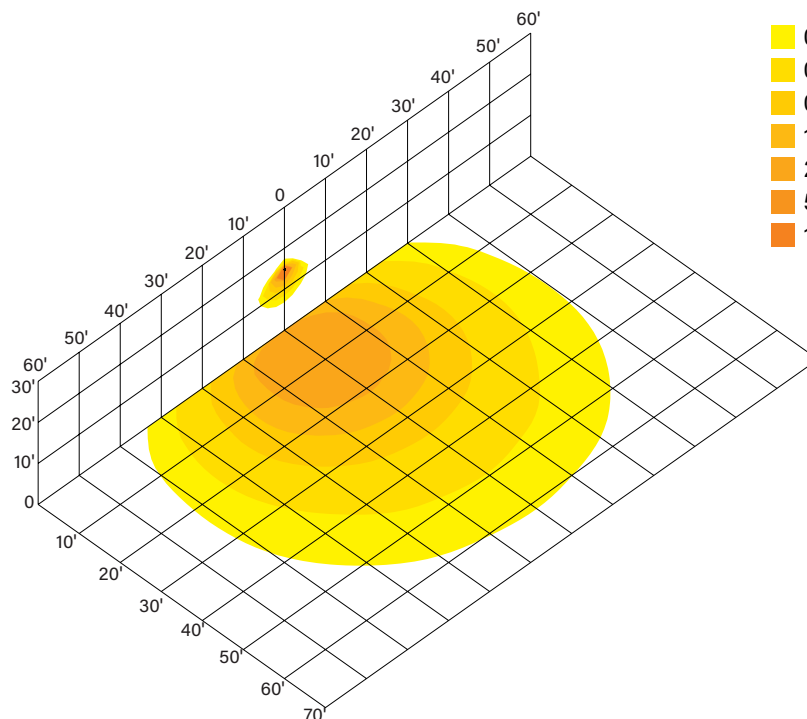

- 0.1fc
- 0.2fc
- 0.5fc
- 1fc
- 2fc
- 5fc
- 10fc

**KT-WPLEDXXPS-X4-8CSB-VDIM**  
TRADITIONAL-SLIM LED WALL PACK

**PHOTOMETRIC SPECIFICATIONS (CONTINUED)**

KT-WPLED55PS-M4-8CSB-VDIM

**ISOCANDELA PLOT**

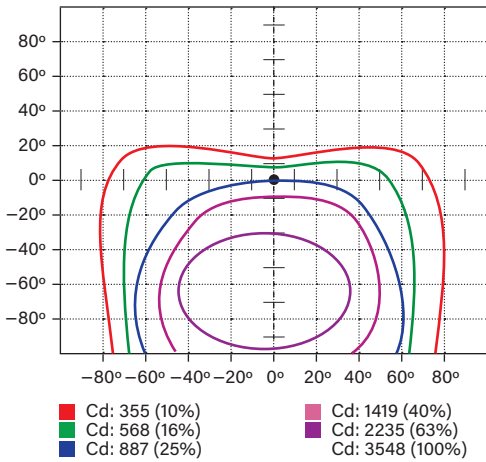

**LUMINOUS INTENSITY DISTRIBUTION**

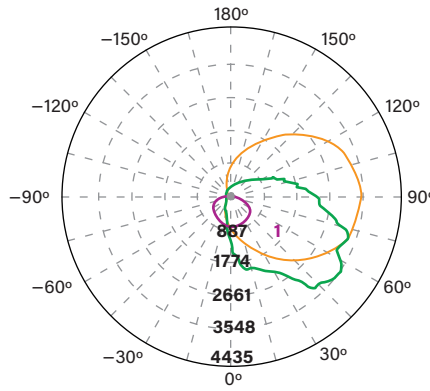

**FLUX DISTRIBUTION**

Zone	Lumens	% Luminaire
<b>Forward Light</b>	5,825 lm	77.1%
0°-30°	676 lm	8.9%
30°-60°	2,399 lm	31.7%
60°-80°	1,997 lm	26.4%
80°-90°	752 lm	10.0%
<b>Back Light</b>	402 lm	5.3%
0°-30°	148 lm	2.0%
30°-60°	161 lm	2.1%
60°-80°	76 lm	1.0%
80°-90°	18 lm	0.2%
<b>Up Light</b>	1,330 lm	17.6%
90°-100°	555 lm	7.3%
100°-180°	775 lm	10.3%

BUG* Rating	
<b>Asymmetrical Luminaire Types</b>	
Type I, II, III, IV	B1 U5 G5
<b>Quadrilateral Symmetrical Luminaire Types</b>	
Type V, Area Light	B1 U5 G5

**MOUNTING**

Side view

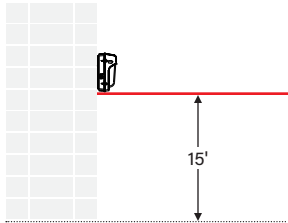

**LIGHT DISTRIBUTION PATTERN**

Isometric view from above; Luminaire mounted at 15'

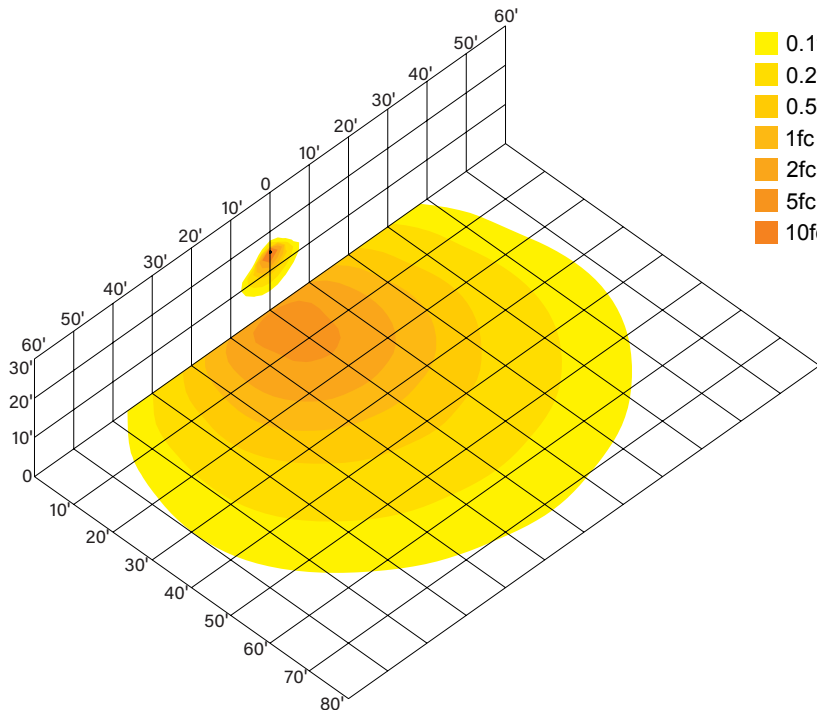

\* Backlight, Uplight, Glare

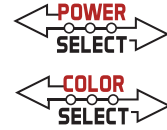

# KT-WPLEDXXPS-X4-8CSB-VDIM

## TRADITIONAL-SLIM LED WALL PACK

### PHOTOMETRIC SPECIFICATIONS (CONTINUED)

KT-WPLED80PS-M4-8CSB-VDIM

#### ISOCANDELA PLOT

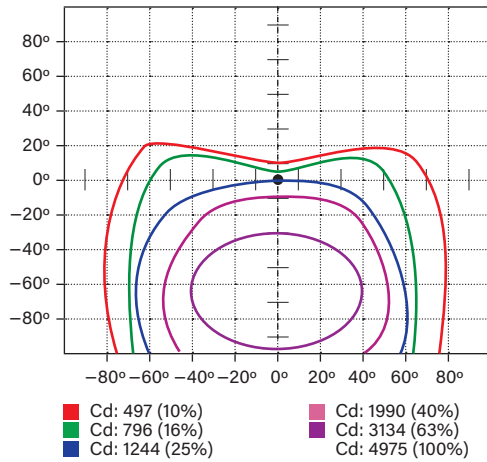

#### LUMINOUS INTENSITY DISTRIBUTION

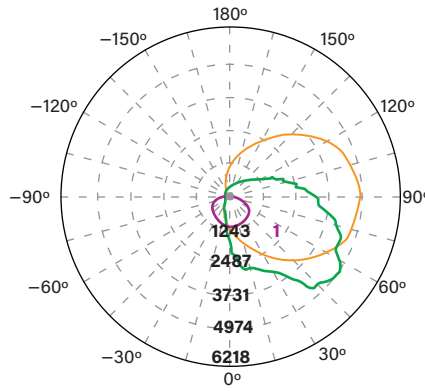

Average diffuse angle (50%): 122.7°

- 1 Violet C0 - C180
- 2 Green C90 - C270
- 3 Orange G56

Unit: cd

#### FLUX DISTRIBUTION

Zone	Lumens	% Luminaire
<b>Forward Light</b>	8,333 lm	77.0%
0°-30°	985 lm	9.1%
30°-60°	3,431 lm	31.7%
60°-80°	2,829 lm	26.1%
80°-90°	1,088 lm	10.1%
<b>Back Light</b>	561 lm	5.2%
0°-30°	201 lm	1.9%
30°-60°	219 lm	2.0%
60°-80°	113 lm	1.0%
80°-90°	27 lm	0.2%
<b>Up Light</b>	1,929 lm	17.8%
90°-100°	790 lm	7.3%
100°-180°	1,139 lm	10.5%

#### BUG\* Rating

##### Asymmetrical Luminaire Types

Type I, II, III, IV B1 U5 G5

##### Quadrilateral Symmetrical Luminaire Types

Type V, Area Light B1 U5 G5

\* Backlight, Uplight, Glare

#### MOUNTING

Side view

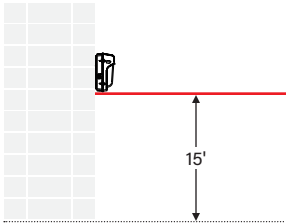

#### LIGHT DISTRIBUTION PATTERN

Isometric view from above; Luminaire mounted at 15'

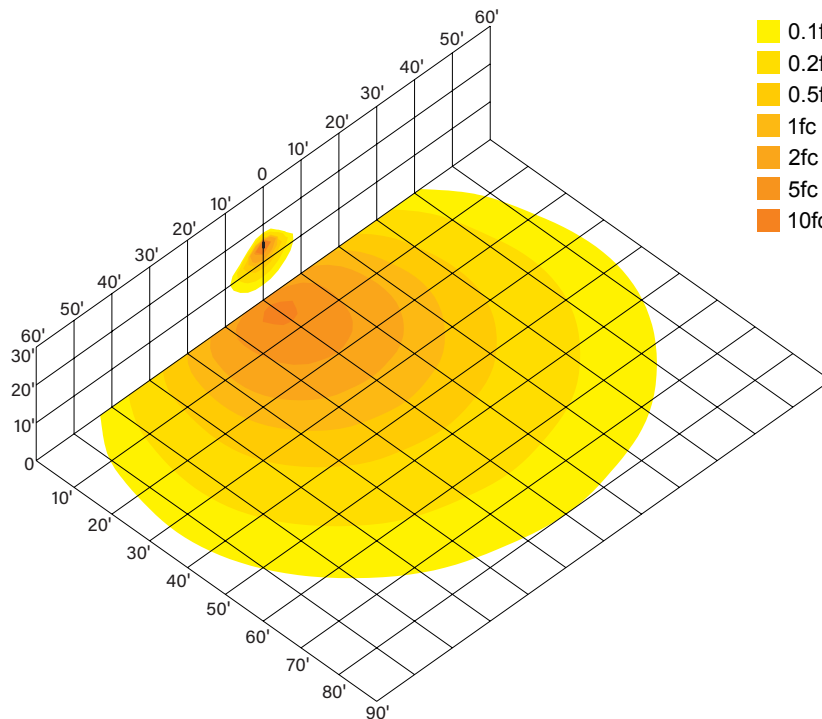

# KT-WPLEDXXPS-X4-8CSB-VDIM

## TRADITIONAL-SLIM LED WALL PACK

**PHOTOMETRIC SPECIFICATIONS (CONTINUED)**

KT-WPLED120PS-L4-8CSB-VDIM

**ISOCANDELA PLOT**

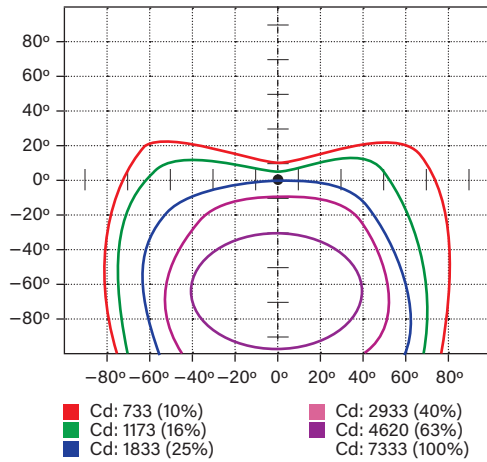

**LUMINOUS INTENSITY DISTRIBUTION**

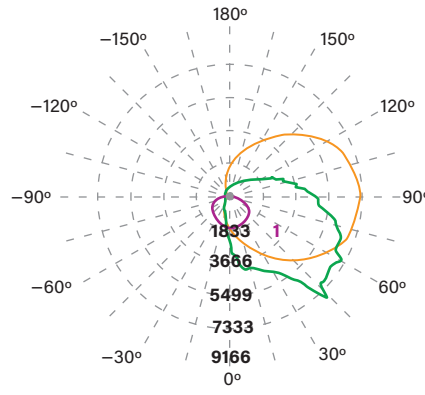

Average diffuse angle (50%): **121.5°**

- 1 Violet C0 - C180
- 2 Green C90 - C270
- 3 Orange G44

Unit: cd

**FLUX DISTRIBUTION**

Zone	Lumens	% Luminaire
<b>Forward Light</b>	12,129 lm	75.2%
0°-30°	1,378 lm	8.5%
30°-60°	5,094 lm	31.6%
60°-80°	4,060 lm	25.2%
80°-90°	1,597 lm	9.9%
<b>Back Light</b>	979 lm	6.1%
0°-30°	382 lm	2.4%
30°-60°	381 lm	2.4%
60°-80°	173 lm	1.1%
80°-90°	43 lm	0.3%
<b>Up Light</b>	3,022 lm	18.7%
90°-100°	1,131 lm	7.0%
100°-180°	1,891 lm	11.7%

**BUG\* Rating**

**Asymmetrical Luminaire Types**

Type I, II, III, IV	B1 U5 G5
---------------------	----------

**Quadrilateral Symmetrical Luminaire Types**

Type V, Area Light	B1 U5 G5
--------------------	----------

\* Backlight, Uplight, Glare

**MOUNTING**

Side view

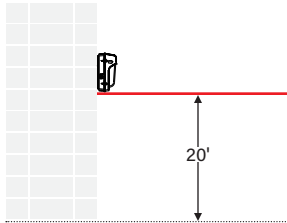

**LIGHT DISTRIBUTION PATTERN**

Isometric view from above; Luminaire mounted at 20'

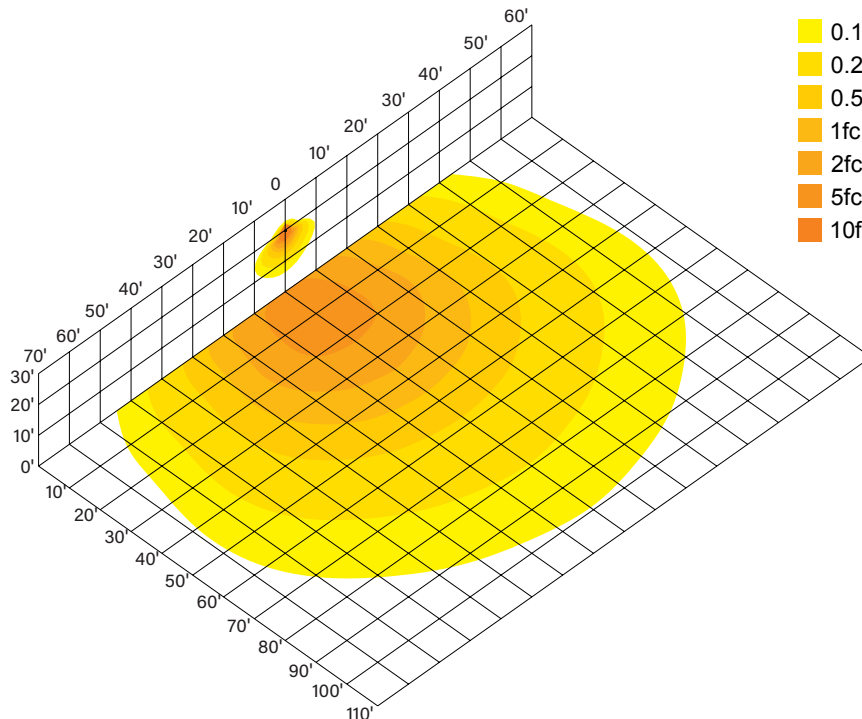

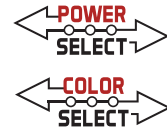

# KT-WPLEDXXPS-X4-8CSB-VDIM

## TRADITIONAL-SLIM LED WALL PACK

### ACCESSORIES

#### SENSORS

**Factory-Installable OR Field-Installable** (field-installable purchased separately)

✓	SUFFIX*	CATALOG NUMBER	DESCRIPTION	UPC	EASY CODE
	/MW3	KTS-MW3-UV-KO-K1	Microwave sensor kit   Includes 120-277V input to 12V DC convertor & 12V input sensor head   Bi-level control with adjustable hold time, dim level, and standby time   Installs via 1/2" KO	843654134147	BKG-51



*\* For factory installation of accessory, add suffix to fixture part number (see ordering examples and instructions on last page of spec sheet).*

#### MOUNTS AND BRACKETS

**Field-Installable / Field-Use ONLY** (purchased separately)

✓	SUFFIX*	CATALOG NUMBER	DESCRIPTION	UPC	EASY CODE
	-	KT-WPLED-BP-M	Wall mount pack plate   Used on medium housings   Covers legacy style large HID housing dimensions   Bronze	843654130613	CCJ-21

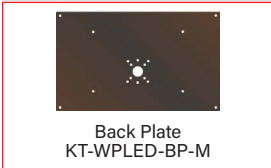

#### SURGE PROTECTORS

**Factory-Installable OR Field-Installable** (field-installable purchased separately)

✓	SUFFIX*	CATALOG NUMBER	DESCRIPTION	UPC	EASY CODE
	/10KV	KTSP-10KV-C	External surge protector   Compact design   Parallel wiring 120-277V input   Max peak protection (10kV, 10kA)	843654129204	BUU-26



*\* For factory installation of accessory, add suffix to fixture part number (see ordering examples and instructions on last page of spec sheet).*

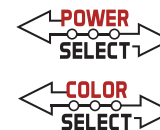

# KT-WPLEDXXPS-X4-8CSB-VDIM

## TRADITIONAL-SLIM LED WALL PACK

### ACCESSORIES (CONTINUED)

#### WIRE GUARDS

Field-Installable / Field-Use ONLY (purchased separately)

✓	SUFFIX*	CATALOG NUMBER	DESCRIPTION	UPC	EASY CODE
	-	KT-WPLED-WG-M4-KIT	Wire guard   Medium housing	843654164496	GWK-39
	-	KT-WPLED-WG-L4-KIT	Wire guard   Large housing	843654164502	VAV-23



### ORDERING INFORMATION

CATALOG NUMBER	UPC	EASY CODE	DLC PRODUCT ID
KT-WPLED35PS-M4-8CSB-VDIM	843654155524	RKA-78	S-V0YXPZ
KT-WPLED35PS-M4-8CSB-VDIM /TAA	843654158730	BQC-61	
KT-WPLED55PS-M4-8CSB-VDIM	843654155531	YZT-68	S-IRMB5P
KT-WPLED55PS-M4-8CSB-VDIM /TAA	843654158747	BHV-30	
KT-WPLED80PS-M4-8CSB-VDIM	843654155548	UCX-21	S-4GY3DL
KT-WPLED80PS-M4-8CSB-VDIM /TAA	843654158754	MLX-00	
KT-WPLED120PS-L4-8CSB-VDIM	843654155555	XCB-90	S-1L09M4
KT-WPLED120PS-L4-8CSB-VDIM /TAA	843654158761	HUL-17	

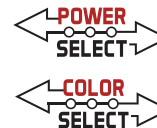

# KT-WPLEDXXPS-X4-8CSB-VDIM

## TRADITIONAL-SLIM LED WALL PACK

### CATALOG NUMBER BREAKDOWN

# KT-WPLEDXXPS-X4-8CSB-VDIM

<b>1</b>	<b>2</b>	<b>3</b>	<b>4</b>	<b>5</b>	<b>6</b>	<b>7</b>	<b>8</b>	<b>9</b>	<b>10</b>	<b>11</b>	<b>12</b>	<b>13</b>
<b>1 Keystone Technologies</b>	<b>2 Fixture Type</b>	<b>3 LED Lamp</b>	<b>4 Max Wattage</b>	<b>5 Power Select</b>	<b>6 Size</b>	<b>7 Style</b>	<b>8 CRI</b>	<b>9 Color Select</b>	<b>10 Color Select Designation</b>	<b>11 Dimming</b>	<b>12 Accessories (see below for details)</b>	<b>13 TAA Compliant</b>
	WP   Wall Pack				M   Medium L   Large	4   Traditional-Slim	8   > 80		B   3000/4000/5000K	VDIM   0-10V		/TAA   Made in Mexico

### ORDERING EXAMPLES

FIXTURE WITH SINGLE FACTORY-INSTALLED ACCESSORY

**KT-WPLED35PS-M4-8CSB-VDIM /MW3**

FIXTURE WITH NO FACTORY-INSTALLED ACCESSORIES

**KT-WPLED35PS-M4-8CSB-VDIM**

#### KEYSTONE FIXTURE

CATALOG NUMBER

KT-WPLED35-M4-8CSB-VDIM

#### SENSORS

✓	SUFFIX	CATALOG NUMBER
✓	/MW3	KTS-MW3-UV-KO-K1

\* When ordering more than one factory-installed accessory, use multiple suffixes as shown in the ordering examples above.  
**Note:** All accessories can also be ordered separately for field installation using just their regular Catalog Number, UPC, or Easy Code.