



KT-RKITXXPS-XXDC-8CSA-VDIM /XX

LED CENTER BASKET RETROFIT KIT

DESCRIPTION

LED Center Basket Fixtures | 120 – 277V Input | Frosted Lens |
0 –10V Dimming

APPLICATION

Used for commercial recessed ceiling applications

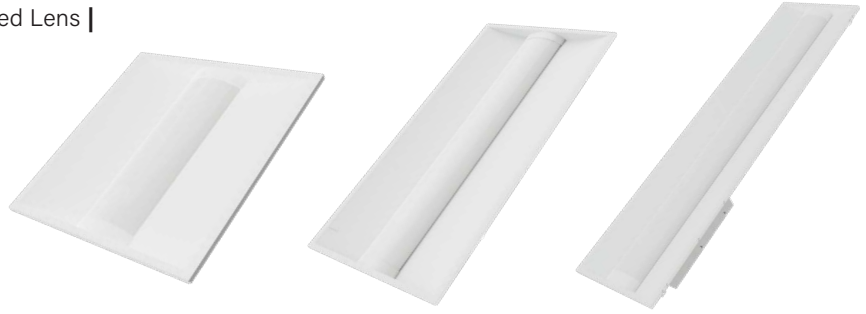

10 YEAR LIMITED WARRANTY

PRODUCT FEATURES

- Features Keystone Power Select technology. (see Performance Specifications for details)
- Features Keystone Color Select technology. Adjust CCT between 3500/4000/5000K
- Powered by Keystone 0 –10V dimming LED drivers with 12V Aux
- Architectural grade center basket volumetric design
- LED lifetime: L70 >100,000 hours @ 25°C fixture ambient
- Ambient operating temperature: -20°C/-4°F to 40°C/104°F
- Compatible with Keystone SmartSafe emergency backups
- Available with Keystone’s Smart Loop Bluetooth™ mesh wireless system, with features such as high-end trim, grouping, occupancy/vacancy sensing, and scheduling.
- Low optical flicker
- THD: < 20%
- Power factor > 0.95
- IC Rated
- Meets FCC Part 15, Class B
- LED chip lifetime: L70 >100,000 hours @ 25°C/77°F ambient fixture temperature

PERFORMANCE SPECIFICATIONS OVERVIEW

Catalog Number	Size	Input Voltage	Selectable Wattage	Selectable CCT	Lumen Output	Efficacy	CRI	Lifetime
KT-RKIT35PS-14DC-8CSA-VDIM /CR	1x4	120-277V	24/30/35W	3500K /4000K /5000K	3120/3900/4550lm	130 lm/W	> 80	50,000 hrs
KT-RKIT24PS-22DC-8CSA-VDIM /CR	2x2		15/18/24W		1950/2340/3120lm			
KT-RKIT35PS-22DC-8CSA-VDIM /CR	2x2		24/30/35W		3120/3900/4550lm			
KT-RKIT30PS-24DC-8CSA-VDIM /CR	2x4		20/25/30W		2600/3250/3900lm			
KT-RKIT45PS-24DC-8CSA-VDIM /CR	2x4		30/38/45W		3900/4940/5850lm			

* Preset to highest lumen output
* Color Uniformity: CCT (Correlated Color Temperature) range as per guidelines outlined in ANSI C78.377-2017

CONTROLS READY

Features a Control Ready design that allows the installation of multitude of sensor options, including Keystone’s Smart loop System. See chart below for possible sensor solutions and page 11 for all Ordering Options.



/CR Endcap- Features a Controls ready solution that can be used with or without KTSL-FC5-12V-IM-PIR Sensor



/FC5 Endcap- Features a preinstalled KTSL-FC5-PIR-IM Smartloop Sensor for quick and easy installation on the jobsite



Custom Sensor Solution Endcap - please contact keystone for more information... lead times and MOQ may apply

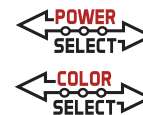

KT-RKITXXPS-XXDC-8CSA-VDIM /XX

LED CENTER BASKET RETROFIT KIT

PRODUCT SPECIFICATIONS DETAILED

Catalog Number	Size	Input Voltage	Wattage	CCT	Lumen Output	Efficacy
KT-RKIT35PS-14DC-8CSA-VDIM /CR	1x4	120-277V	24W	3500K	3240	130lm/W
				4000K	3312	134lm/W
				5000K	3336	135lm/W
			30W	3500K	3900	128lm/W
				4000K	4050	132lm/W
				5000K	4080	133lm/W
			35W	3500K	4375	125lm/W
				4000K	4515	129lm/W
				5000K	4550	130lm/W
KT-RKIT24PS-22DC-8CSA-VDIM /CR	2x2	120-277V	15W	3500K	2025	130lm/W
				4000K	2070	134lm/W
				5000K	2085	135lm/W
			18W	3500K	2340	128lm/W
				4000K	2430	132lm/W
				5000K	2448	133lm/W
			24W	3500K	3000	125lm/W
				4000K	3096	129lm/W
				5000K	3120	130lm/W
KT-RKIT35PS-22DC-8CSA-VDIM /CR	2x2	120-277V	24W	3500K	3240	130lm/W
				4000K	3312	134lm/W
				5000K	3336	135lm/W
			30W	3500K	3900	128lm/W
				4000K	4050	132lm/W
				5000K	4080	133lm/W
			35W	3500K	4375	125lm/W
				4000K	4515	129lm/W
				5000K	4550	130lm/W
KT-RKIT30PS-24DC-8CSA-VDIM /CR	2x4	120-277V	20W	3500K	2700	130lm/W
				4000K	2760	134lm/W
				5000K	2780	135lm/W
			25W	3500K	3250	128lm/W
				4000K	3375	132lm/W
				5000K	3400	133lm/W
			30W	3500K	3750	125lm/W
				4000K	3870	129lm/W
				5000K	3900	130lm/W



KT-RKITXXPS-XXDC-8CSA-VDIM /XX

LED CENTER BASKET RETROFIT KIT

PRODUCT SPECIFICATIONS DETAILED (CONTINUED)

KT-RKIT45PS-24DC-8CSA-VDIM /CR	2x4	120-277V	30W	3500K	4050	130lm/W
				4000K	4140	134lm/W
				5000K	4170	135lm/W
			38W	3500K	4940	128lm/W
				4000K	5130	132lm/W
				5000K	5168	133lm/W
			45W	3500K	5625	125lm/W
				4000K	5805	129lm/W
				5000K	5850	130lm/W

PHOTOMETRIC SPECIFICATIONS

KT-RKIT35PS-14DC-8CSA-VDIM /CR

ISOCANDELA PLOT

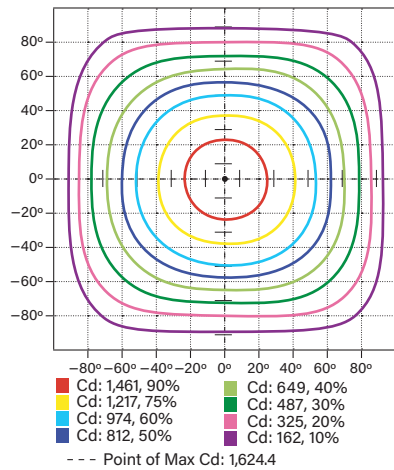

POLAR CANDELA DISTRIBUTION

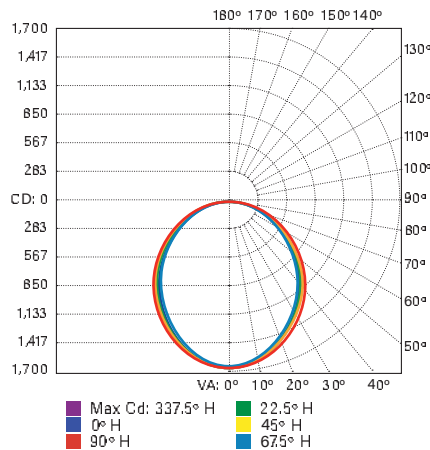

ZONAL LUMEN SUMMARY

Zone	Lumens	% Luminaire
0-30	1,234.5	28%
0-40	1,994.6	45.3%
0-60	3,446.7	78.2%
60-90	954.9	21.7%
70-100	422.9	9.6%
90-120	0.8	0%
0-90	4,401.5	99.9%
90-180	3.7	0.1%
0-180	4,405.2	100%

FLUX CHART

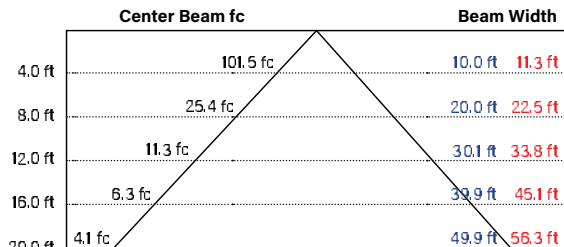

Height ■ Vertical Spread: 102.6°
 ■ Horizontal Spread: 109.3°

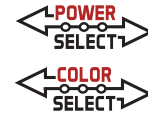

KT-RKITXXPS-XXDC-8CSA-VDIM /XX

LED CENTER BASKET RETROFIT KIT

PHOTOMETRIC SPECIFICATIONS (CONTINUED)

KT-RKIT24PS-22DC-8CSA-VDIM /CR

ISOCANDELA PLOT

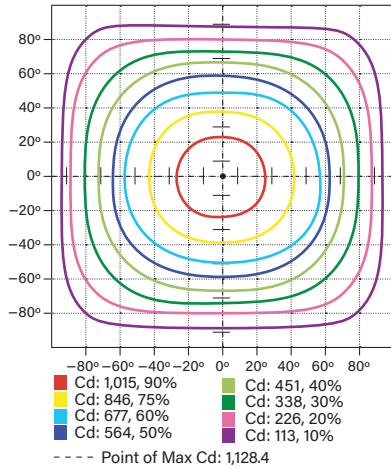

POLAR CANDELA DISTRIBUTION

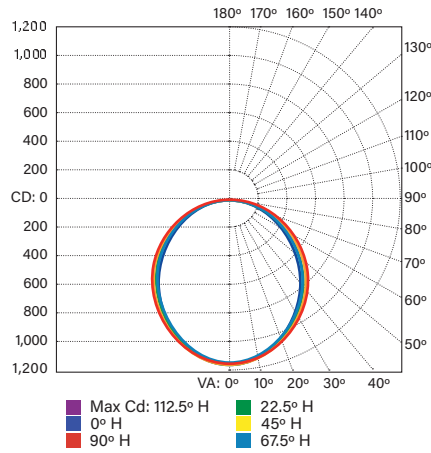

ZONAL LUMEN SUMMARY

Zone	Lumens	% Luminaire
0-30	864.6	27.3%
0-40	1,406.2	44.4%
0-60	2,462.7	77.7%
60-90	705.8	22.3%
70-100	315.2	9.9%
90-120	0.0	0%
0-90	3,168.5	100%
90-180	0.4	0%
0-180	3,168.8	100%

FLUX CHART

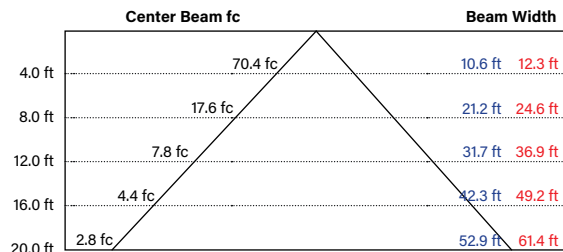

■ Vertical Spread: 105.8°
■ Horizontal Spread: 113.9°



KT-RKITXXPS-XXDC-8CSA-VDIM /XX

LED CENTER BASKET RETROFIT KIT

PHOTOMETRIC SPECIFICATIONS (CONTINUED)

KT-RKIT35PS-22DC-8CSA-VDIM /CR

ISOCANDELA PLOT

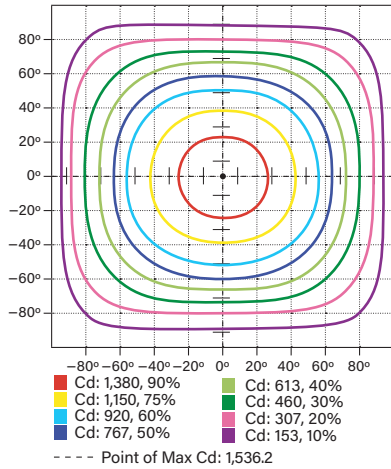

POLAR CANDELA DISTRIBUTION

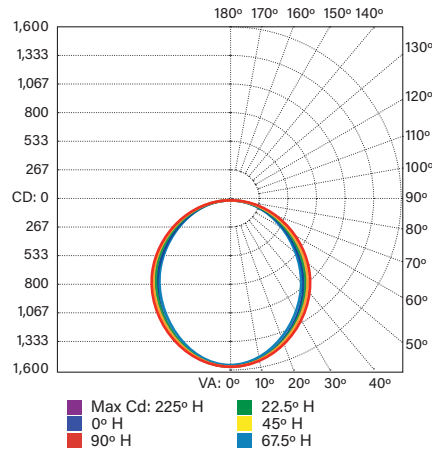

ZONAL LUMEN SUMMARY

Zone	Lumens	% Luminaire
0-30	1,177.7	27.3%
0-40	1,915.7	44.3%
0-60	3,354.6	77.6%
60-90	963.4	22.3%
70-100	431.2	10%
90-120	0.4	0%
0-90	4,318.1	99.9%
90-180	2.3	0.1%
0-180	4,320.4	100%

FLUX CHART

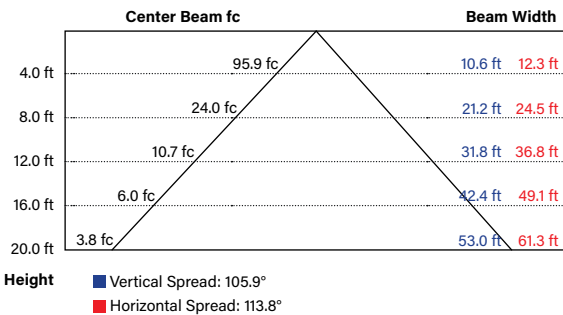



KT-RKITXXPS-XXDC-8CSA-VDIM /XX

LED CENTER BASKET RETROFIT KIT

PHOTOMETRIC SPECIFICATIONS (CONTINUED)

KT-RKIT30PS-24DC-8CSA-VDIM /CR

ISOCANDELA PLOT

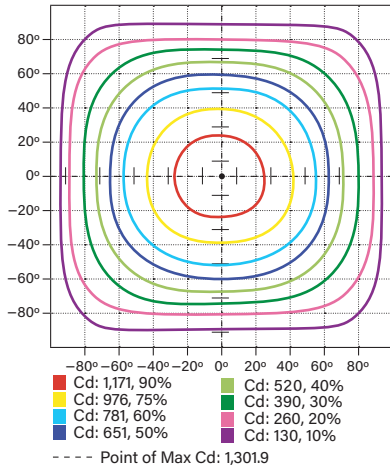

POLAR CANDELA DISTRIBUTION

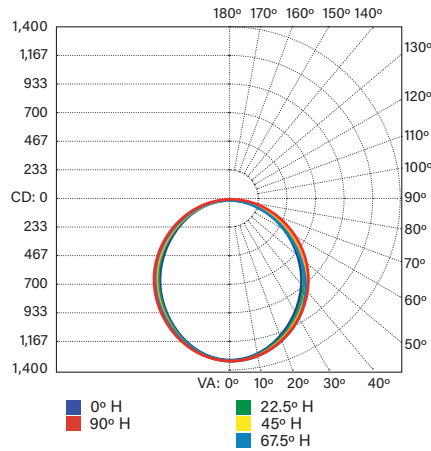

ZONAL LUMEN SUMMARY

Zone	Lumens	% Luminaire
0-30	1,000.0	27%
0-40	1,629.4	44%
0-60	2,861.6	77.3%
60-90	838.8	22.7%
70-100	380.4	10.3%
90-120	0.1	0%
0-90	3,700.5	100%
90-180	0.1	0%
0-180	3,700.5	100%

FLUX CHART

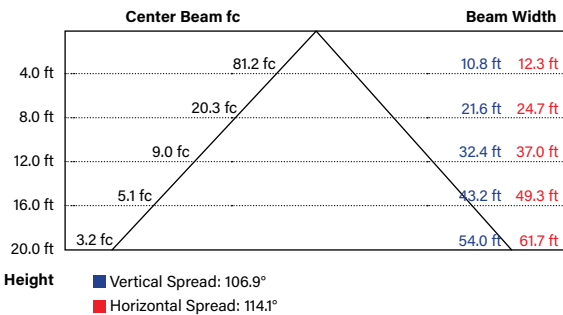



KT-RKITXXPS-XXDC-8CSA-VDIM /XX

LED CENTER BASKET RETROFIT KIT

PHOTOMETRIC SPECIFICATIONS (CONTINUED)

KT-RKIT45PS-24DC-8CSA-VDIM /CR

ISOCANDELA PLOT

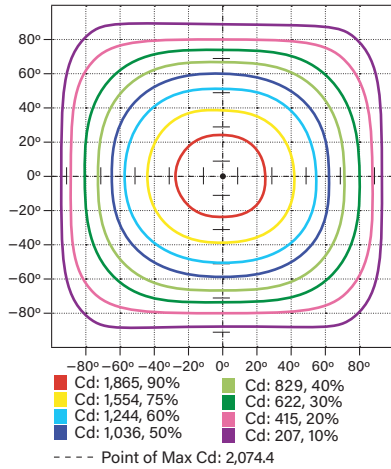

POLAR CANDELA DISTRIBUTION

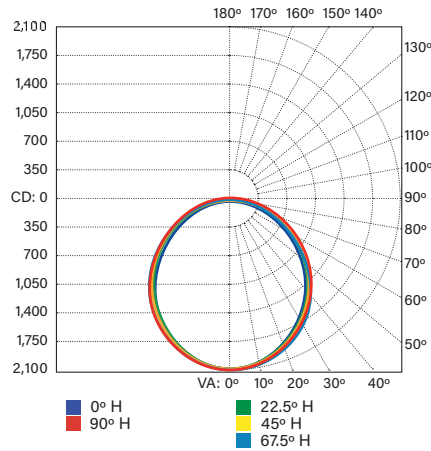

ZONAL LUMEN SUMMARY

Zone	Lumens	% Luminaire
0-30	1,594.8	27%
0-40	2,598.3	44%
0-60	4,564.5	77.3%
60-90	1,338.6	22.7%
70-100	607.9	10.3%
90-120	2.9	0%
0-90	5,903.1	99.9%
90-180	4.2	0.1%
0-180	5,907.3	100%

FLUX CHART

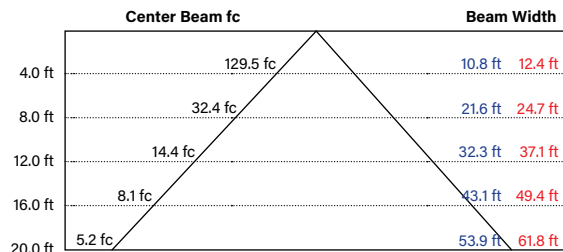

■ Vertical Spread: 106.8°
■ Horizontal Spread: 114.2°



KT-RKITXXPS-XXDC-8CSA-VDIM /XX

LED CENTER BASKET RETROFIT KIT

POWER AND COLOR TEMPERATURE SELECTABILITY

- Keystone Color Select Technology: Adjustable CCT (3500/4000/5000K)
- Keystone Power Select Technology: Adjustable Wattage

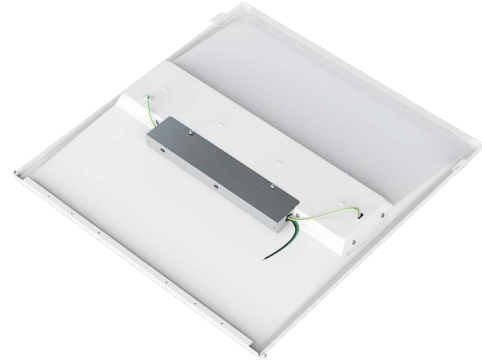

WIRING DIAGRAMS

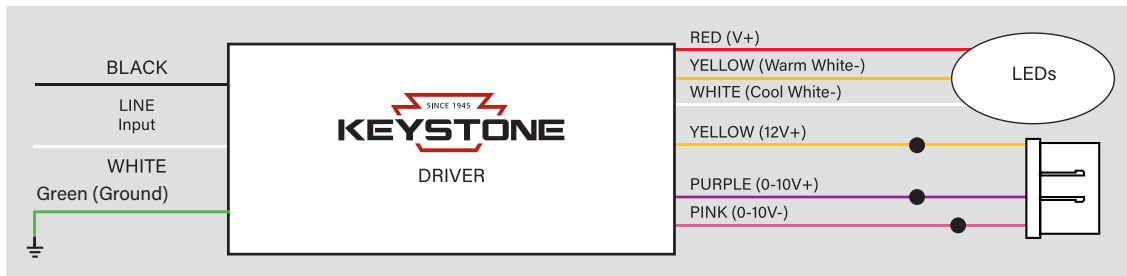



KT-RKITXXPS-XXDC-8CSA-VDIM /XX

LED CENTER BASKET RETROFIT KIT

PHYSICAL SPECIFICATIONS

KT-RKIT35PS-14DC-8CSA-VDIM /CR

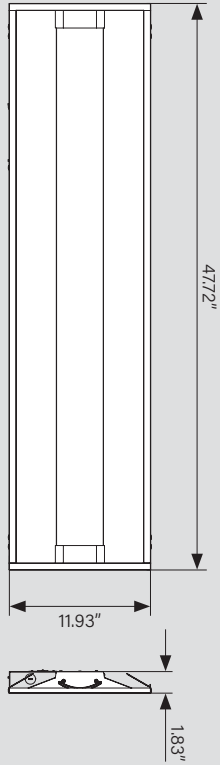

KT-RKIT30PS-24DC-8CSA-VDIM /CR
KT-RKIT45PS-24DC-8CSA-VDIM /CR

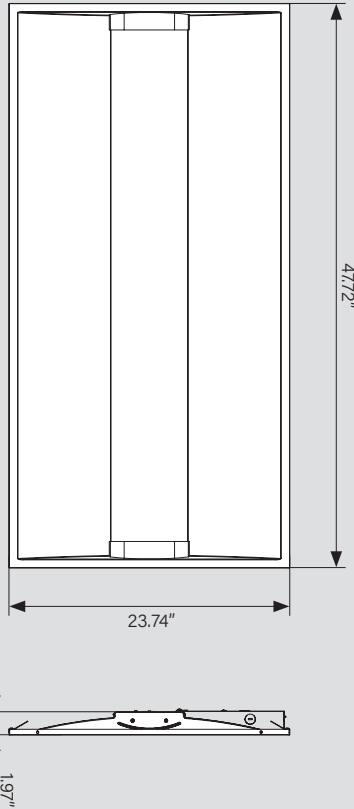

KT-RKIT24PS-22DC-8CSA-VDIM /CR
KT-RKIT35PS-22DC-8CSA-VDIM /CR

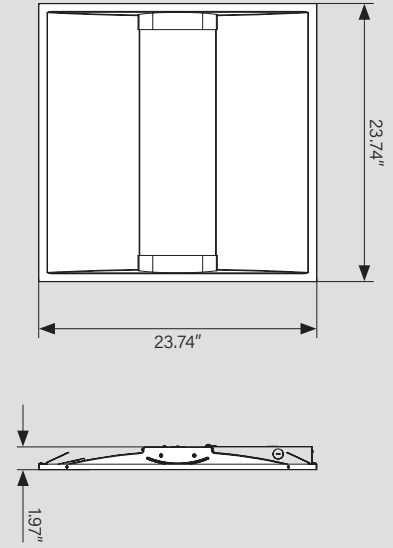

KT-RKITXXPS-XXDC-8CSA-VDIM /XX

LED CENTER BASKET RETROFIT KIT

ACCESSORIES

SENSORS

Factory-Installable OR Field-Installable (field-installable purchased separately)

✓	SUFFIX*	CATALOG NUMBER	DESCRIPTION	UPC	EASY CODE
	/FC5	KTSL-FC5-12V-IM-PIR	Bluetooth mesh wireless low voltage individual fixture controller for LLLC SmartLoop system with integrated daylight and PIR motion sensors, 12V, 0-10V Dimming, Integral mount	843654164342	ODF-32



Wireless Fixture Controller
 KTSL-FC5-12V-IM-PIR

EMERGENCY BACKUP

Factory-Installable OR Field-Installable (field-installable purchased separately)

✓	SUFFIX*	CATALOG NUMBER	DESCRIPTION	UPC	EASY CODE
	/EM4	KT-EMRG-LED-4BC-400-EN2	4W, 400 lumen Smart Safe Emergency Backup, CEC T20 Compliant	843654175515	DQN-36
	/EM5†	KT-EMRG-LED-5C-500-EN /DF	5W, 500 Lumen Smart Safe Emergency Backup with Dual Flex, CEC T20 Compliant	843654132433	RAR-74
	/EM10†	KT-EMRG-LED-10BC-1000-EN3 /DF	10W, 1000 Lumen Smart Safe Emergency Backup with Dual Flex, CEC T20 Compliant	843654167619	KNI-42
	/EM12†	KT-EMRG-LED-12C-1200-EN /DF	12W, 1200 Lumen Smart Safe Emergency Backup with Dual Flex, CEC T20 Compliant	843654103112	OJQ-32



4W, 400 lumen Battery Backup
 KT-EMRG-LED-4BC-400-EN2



5W, 500 lumen Battery Backup
 KT-EMRG-LED-5C-500-EN /DF



10W, 1000 lumen Battery Backup
 KT-EMRG-LED-10BC-1000-EN3 /DF



12W, 1200 lumen Battery Backup
 KT-EMRG-LED-12C-500-EN /DF

* FOR FACTORY INSTALLATION OF ACCESSORY, ADD SUFFIX TO FIXTURE PART NUMBER (SEE ORDERING EXAMPLES AND INSTRUCTIONS ON LAST PAGE OF SPEC SHEET).
 † FACTORY INSTALLATION OF EMERGENCY BACKUP UNITS WILL AUTOMATICALLY INCLUDE ANY RELEVANT MOUNTING BRACKET.

Field-Installable / Field-Use ONLY (purchased separately)

CATALOG NUMBER	DESCRIPTION	UPC	EASY CODE
KT-RKIT-DC-EM-KIT	Emergency LED Backup Mounting Kit for Keystone Center Basket Doorframe Kits. Includes Bracket and mounting hardware.	843654163857	AOD-96

(Accessories continued on next page)

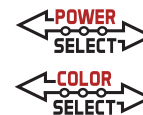

KT-RKITXXPS-XXDC-8CSA-VDIM /XX

LED CENTER BASKET RETROFIT KIT

ORDERING INFORMATION

CATALOG NUMBER	CARTON QTY.	UPC	EASY CODE	DLC PRODUCT ID
KT-RKIT35PS-14DC-8CSA-VDIM /CR	1	843654166056	LYK-62	S-0RKG2N
KT-RKIT24PS-22DC-8CSA-VDIM /CR	1	843654166063	VCM-48	S-7H8DGZ
KT-RKIT35PS-22DC-8CSA-VDIM /CR	1	843654166070	YXR-99	S-GYMK4P
KT-RKIT30PS-24DC-8CSA-VDIM /CR	1	843654166087	KEG-26	S-WM06N5
KT-RKIT45PS-24DC-8CSA-VDIM /CR	1	843654166094	BWS-44	S-YQQNW2
KT-RKIT35PS-14DC-8CSA-VDIM /FC5	1	843654167008	EWB-11	S-0RKG2N
KT-RKIT24PS-22DC-8CSA-VDIM /FC5	1	843654167015	NLA-27	S-7H8DGZ
KT-RKIT35PS-22DC-8CSA-VDIM /FC5	1	843654167022	VUG-66	S-GYMK4P
KT-RKIT30PS-24DC-8CSA-VDIM /FC5	1	843654167039	JAB-48	S-WM06N5
KT-RKIT45PS-24DC-8CSA-VDIM /FC5	1	843654167046	OQW-85	S-YQQNW2
KT-RKIT35PS-14DC-8CSA-VDIM /CR /2PK	2	843654171814	TMB-73	TBD
KT-RKIT24PS-22DC-8CSA-VDIM /CR /2PK	2	843654171821	OPN-91	TBD
KT-RKIT35PS-22DC-8CSA-VDIM /CR /2PK	2	843654171838	QTE-40	TBD
KT-RKIT30PS-24DC-8CSA-VDIM /CR /2PK	2	843654171845	PSQ-76	TBD
KT-RKIT45PS-24DC-8CSA-VDIM /CR /2PK	2	843654171852	RJC-48	TBD

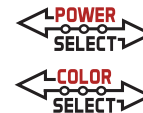

KT-RKITXXPS-XXDC-8CSA-VDIM /XX

LED CENTER BASKET RETROFIT KIT

CATALOG NUMBER BREAKDOWN

KT-RKITXXPS-XXDC-8CSA-VDIM /XX

1 2 3 4 5 6 7 8 9 10 11 12

- 1 Keystone Technologies
- 2 Retrofit Kit
- 3 Max Wattage
- 4 Power Select
- 5 Nominal Size
- 6 Doorframe Kit
- 7 Form Factor C
- 8 80 CRI

- 9 Color Select
- 10 Color Select Designation
- 11 0-10V Dimming
- 12 Aux Power

3 Max Wattage	
24	15/18/24W
30	20/25/30W
35	24/30/35W
45	30/38/45W

10 Color Select Designation	
A	3500K, 4000K, 5000K

5 Nominal Size	
14	1x4
22	2x2
24	2x4

12 Controls	
	No Controls
/CR	Controls Ready
/FC5	Fixture Controller
/2PK	2 Pack

ORDERING EXAMPLES

FIXTURE WITH TWO FACTORY-INSTALLED ACCESSORIES*

KT-RKIT35PS-14DC-8CSA-VDIM /FC5/EM5

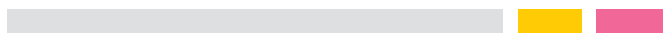

FIXTURE WITH SINGLE FACTORY-INSTALLED ACCESSORY

KT-RKIT35PS-14DC-8CSA-VDIM /FC5

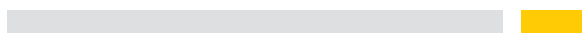

FIXTURE WITH NO FACTORY-INSTALLED ACCESSORIES

KT-RKIT35PS-14DC-8CSA-VDIM

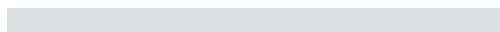

KEYSTONE FIXTURE	
CATALOG NUMBER	
KT-RKIT35PS-14DC-8CSA-VDIM	

SENSORS	
SUFFIX	CATALOG NUMBER
✓ /FC5	KTSL-FC5-12V-IM-PIR

EMERGENCY BACKUP	
SUFFIX	CATALOG NUMBER
✓ /EM5	KT-EMRG-LED-5C-500

* WHEN ORDERING MORE THAN ONE FACTORY-INSTALLED ACCESSORY, USE MULTIPLE SUFFIXES AS SHOWN IN THE ORDERING EXAMPLES ABOVE.
 NOTE: ALL ACCESSORIES CAN ALSO BE ORDERED SEPARATELY FOR FIELD INSTALLATION USING JUST THEIR REGULAR CATALOG NUMBER, UPC, OR EASY CODE.