

KT-ALEDXXXPS-X2-OSB-PMA-8CSB-VDIM-P-X

POLE MOUNTED LED AREA LIGHT PREMIUM PACKAGE

DESCRIPTION

Power and Color Select Area Light with Optic Swap | 120-277V Input | Bronze or White Housing | Adjustable Pole Mount Kit Included

APPLICATION

Pole-mount or structure-mount outdoor illumination needs (including parking lots, auto dealerships, pathways, roadways, recreational venues, and other general area lighting requirements)

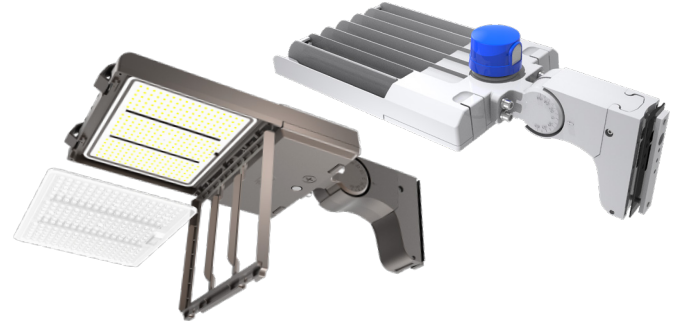

PRODUCT FEATURES

- Keystone Power Select technology (*see Performance Specifications for details*)
- Keystone Color Select technology (3000/4000/5000K)
- Innovative optic swap capability under door frame and latch design for quick, tool-free lens change
- Three lenses in the box: Type III installed, Types IV and V included
- Type II lens sold separately. See below for details
- Heavy-duty, die-cast aluminum housing with ample heat sinking
- Low-profile design delivers high-performance illumination and improves application site aesthetics
- True U0 design for dark sky friendly performance that eliminates undesirable sky glow
- Integrated NEMA/ANSI C136.10 7-pin twist-lock receptacle with 3-pin photocell and shorting cap. Standard on all fixtures, simplifies ordering requirements for photo control needs
- Comes with a pre-installed adjustable pole mount kit for easy and quick mounting to square or round poles. Can be used with KT-ALED-WM-1-KIT, wall mount adaptor (sold separately)
- Keystone 0-10V dimming driver with 6kV surge protection
- Ambient operating temperature: -40°C/-40°F to 50°C/122°F
- UL Certified, IP65 rated
- Power factor: > 0.95
- THD: < 20%
- LED chip lifetime: L70 > 100,000 hrs @ 25°C/77°F ambient fixture temperature
- Meets FCC Part 15, Part B, Class A standards for conducted and radiated emissions

PERFORMANCE SPECIFICATIONS

Catalog No.	Selectable Wattage	Selectable CCT	Lumens	Efficacy	Input Voltage	Dimming	CRI	Distribution Pattern*	Photocell Included	Housing Color**	Legacy Equivalent
KT-ALED140PS-M2-OSB-PMA-8CSB-VDIM-P KT-ALED140PS-M2-OSB-PMA-8CSB-VDIM-P-W	140W	3000K	17,950	128 lm/W	120-277V	0-10V	> 80	Type III Installed, Types IV and V Included	Yes	Bronze or White Available	400W MH
		4000K	20,780	148 lm/W							
		5000K	19,020	136 lm/W							
	100W	3000K	12,720	127 lm/W							
		4000K	14,750	148 lm/W							
		5000K	13,530	135 lm/W							
	70W	3000K	9,310	133 lm/W							
		4000K	10,740	153 lm/W							
		5000K	9,880	141 lm/W							
KT-ALED290PS-L2-OSB-PMA-8CSB-VDIM-P KT-ALED290PS-L2-OSB-PMA-8CSB-VDIM-P-W	290W	3000K	36,320	125 lm/W	120-277V	0-10V	> 80	Type II Available, Sold Separately	Yes	Bronze or White Available	1000W MH
		4000K	42,770	147 lm/W							
		5000K	38,700	133 lm/W							
	210W	3000K	27,300	130 lm/W							
		4000K	31,710	151 lm/W							
		5000K	28,980	138 lm/W							
	185W	3000K	22,970	124 lm/W							
		4000K	27,060	146 lm/W							
		5000K	24,440	132 lm/W							

* For more information, see Accessories page below or contact Keystone with questions.
 ** Fixtures and mounts with alternate housing colors are available and made to order. Extended lead times apply. Please see catalog number breakdown for full ordering code details.

KT-ALEDXXXPS-X2-OSB-PMA-8CSB-VDIM-P-X

POLE MOUNTED LED AREA LIGHT PREMIUM PACKAGE

PHYSICAL SPECIFICATIONS

POLE-MOUNT LED AREA LIGHT FIXTURE

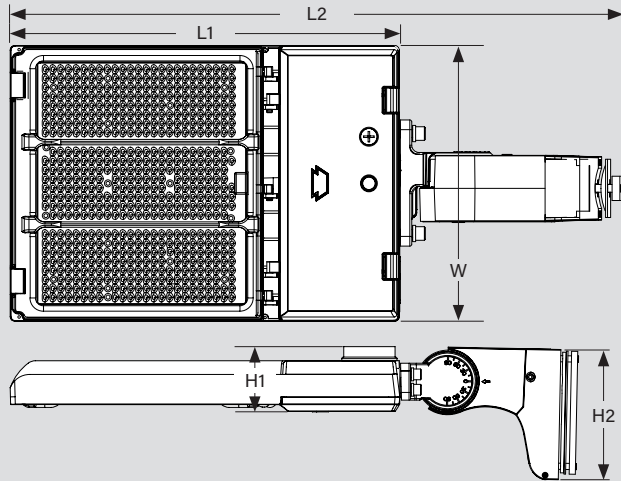

FIXTURE DIMENSIONS

Catalog Number	L1 (Length)	W (Width)	H1 (Height)
KT-ALED140PS-M2-OSB-PMA-8CSB-VDIM-P KT-ALED140PS-M2-OSB-PMA-8CSB-VDIM-P-W	14.13"	9.61"	3.30"
KT-ALED290PS-L2-OSB-PMA-8CSB-VDIM-P KT-ALED290PS-L2-OSB-PMA-8CSB-VDIM-P-W	15.70"	11.18"	3.30"

FIXTURE DIMENSIONS (WITH POLE MOUNT)

Catalog Number	L2 (Length)	H2 (Height)
KT-ALED140PS-M2-OSB-PMA-8CSB-VDIM-P KT-ALED140PS-M2-OSB-PMA-8CSB-VDIM-P-W	14.13"	3.30"
KT-ALED290PS-L2-OSB-PMA-8CSB-VDIM-P KT-ALED290PS-L2-OSB-PMA-8CSB-VDIM-P-W	15.70"	3.30"

PACKAGING DIMENSIONS

Catalog Number	Carton Dimensions	Carton Weight
KT-ALED140PS-M2-OSB-PMA-8CSB-VDIM-P KT-ALED140PS-M2-OSB-PMA-8CSB-VDIM-P-W	5.63" x 13.15" x 26.57"	16.53 lbs
KT-ALED290PS-L2-OSB-PMA-8CSB-VDIM-P KT-ALED290PS-L2-OSB-PMA-8CSB-VDIM-P-W	5.63" x 15.95" x 26.18"	17.53 lbs

ADJUSTABLE POLE MOUNT KIT DRILLING HOLES

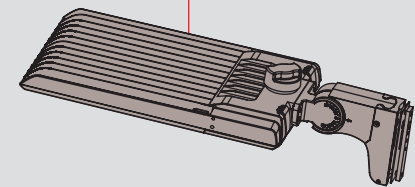
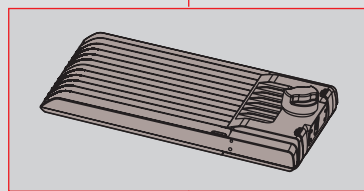
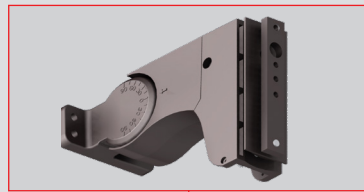
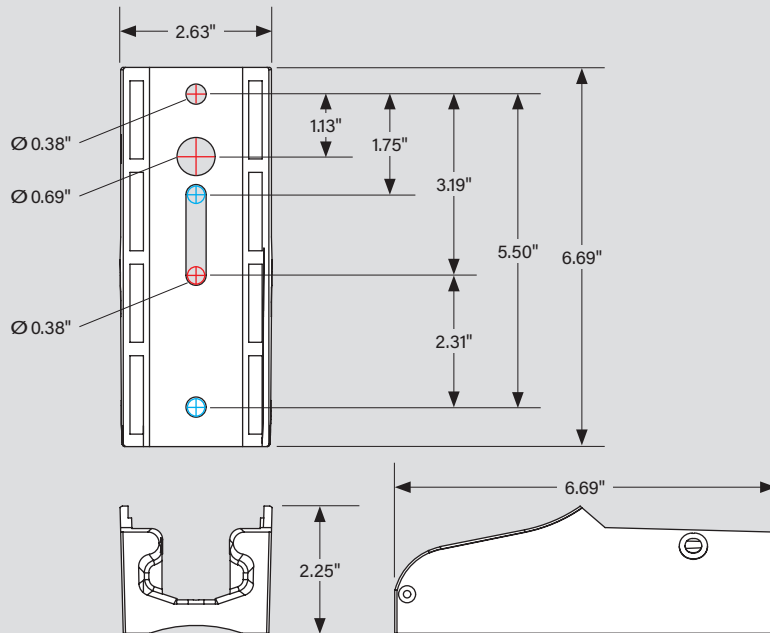



KT-ALEDXXXPS-X2-OSB-PMA-8CSB-VDIM-P-X

POLE MOUNTED LED AREA LIGHT PREMIUM PACKAGE

WIRING DIAGRAM

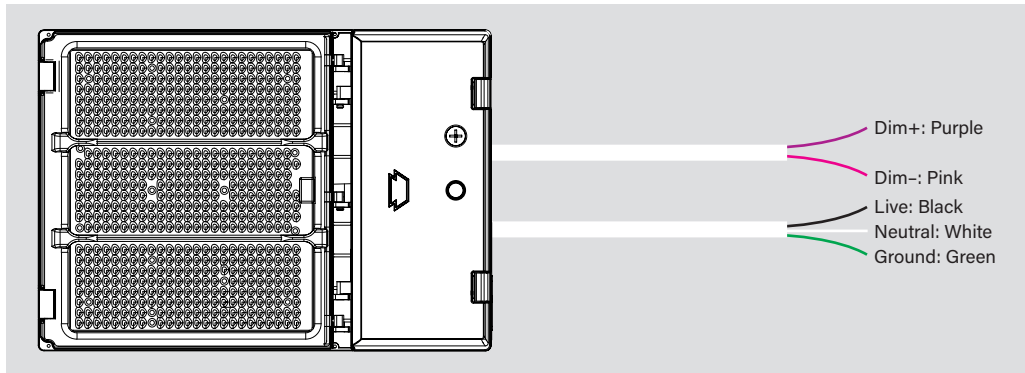

- This fixture comes pre-wired with a 7-pin twist-lock receptacle with shorting cap.
- Make input connections as needed and ensure connections are protected from exposure to the elements.
- **Input voltage rating: 120-277V**
- Ensure that input voltage on site matches the fixture you intend to install.

POWER SELECT (WATTAGE) AND COLOR SELECT (CCT) ADJUSTMENT

This fixture is equipped with field-adjustable Keystone Power Select and Color Select technology.

1. Ensure power is off to the fixture.
2. Open the driver compartment located on the underside of the fixture.
3. Adjust switches to desired settings.

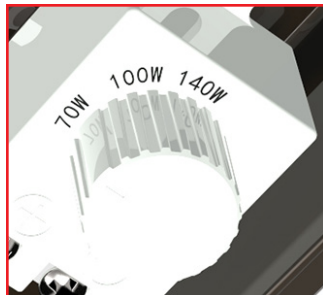

POWER SELECT ADJUSTMENT DIAL
Adjust between high, medium, and low wattage. Fixtures come preset to highest wattage.

Image for reference only. Different SKU's will have different wattages

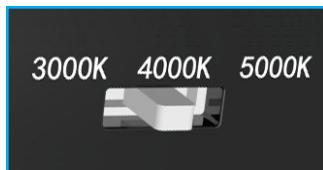

COLOR SELECT ADJUSTMENT SWITCH
Set switch to adjust CCT between 3000K, 4000K, and 5000K. Fixture comes preset at 5000K.

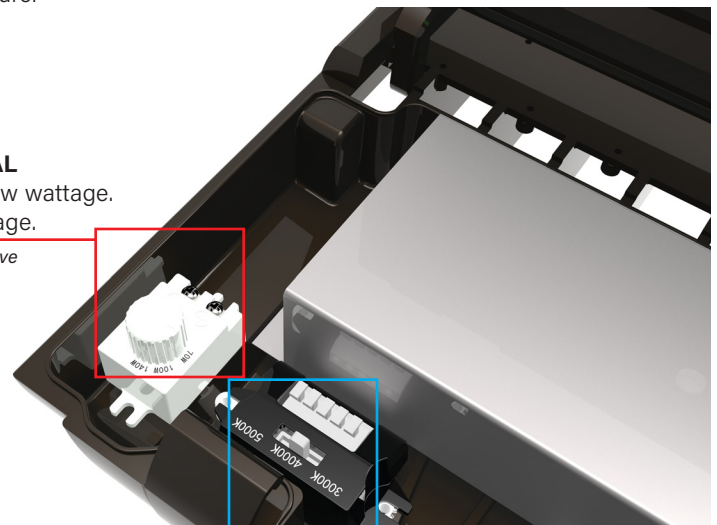

LIGHT DISTRIBUTION PATTERN

Photometric layouts for general reference only. Each square is 10 ft x 10 ft

KT-ALED140PS-M2-OSB-PMA-8CSB-VDIM-P
Pole mounted at 30 ft

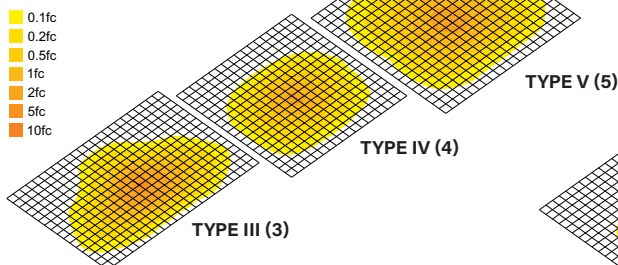

KT-ALED290PS-L2-OSB-PMA-8CSB-VDIM-P
Pole mounted at 35 ft

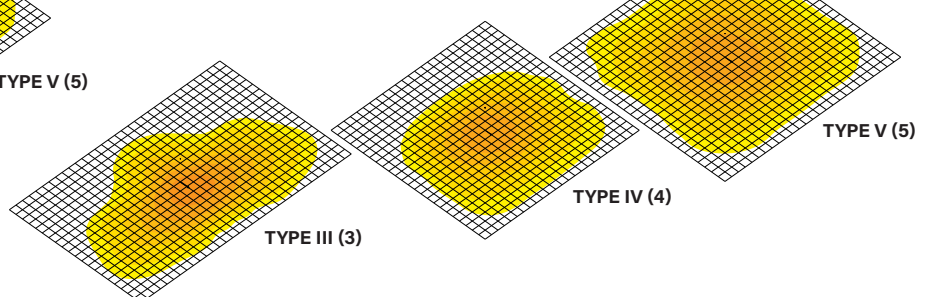

- 0.1fc
- 0.2fc
- 0.5fc
- 1fc
- 2fc
- 5fc
- 10fc



KT-ALEDXXXPS-X2-OSB-PMA-8CSB-VDIM-P-X

POLE MOUNTED LED AREA LIGHT PREMIUM PACKAGE

PHOTOMETRIC SPECIFICATIONS KT-ALED140PS-M2-OSB-PMA-8CSB-VDIM-P (TYPE II [2])

ISOCANDELA PLOT

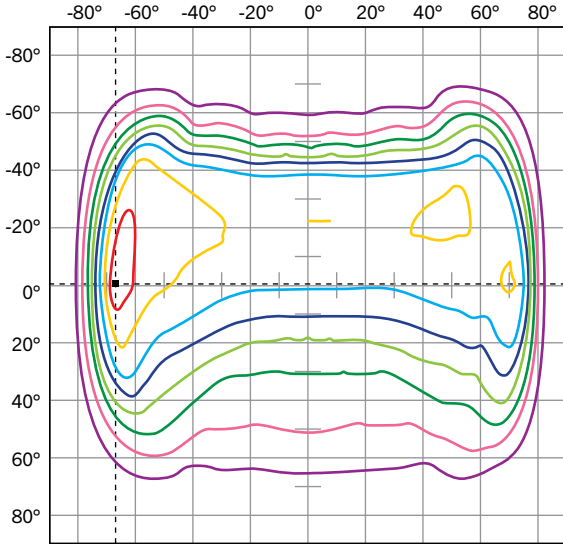

- Point of Max Cd: 9029.9
- Cd: 8051, 90%
- Cd: 6709, 75%
- Cd: 5367, 60%
- Cd: 4473, 50%
- Cd: 3578, 40%
- Cd: 2684, 30%
- Cd: 1789, 20%
- Cd: 895, 10%

POLAR CANDELA DISTRIBUTION

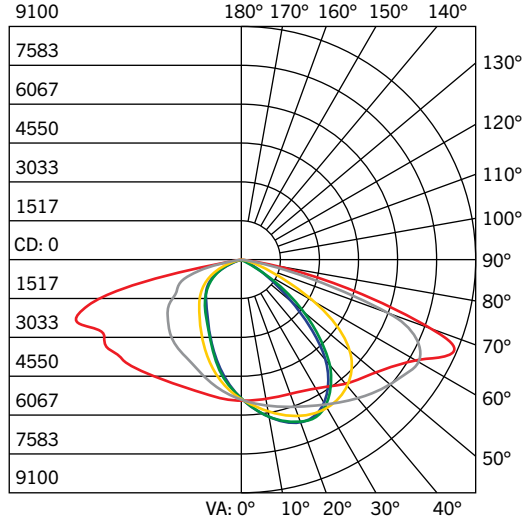

- : 0° H
- : 22.5° H
- : 67.5° H
- : 90° H
- : 45° H

FLUX DISTRIBUTION

Zone	Lumens	% Luminaire
Forward Light		
0°-30°	2635.6	14.2%
30°-60°	6056.9	32.6%
60°-80°	2427.6	13.1%
80°-90°	86.6	0.5%
Back Light		
0°-30°	1792.1	9.6%
30°-60°	3633.2	19.5%
60°-80°	1887.1	10.2%
80°-90°	71.0	0.4%
Up Light		
90°-100°	0.0	0.0%
100°-180°	0.0	0.0%
Total	18590.1	100.0%
BUG Rating	B3-U0-G3	

PHOTOMETRIC SPECIFICATIONS KT-ALED140PS-M2-OSB-PMA-8CSB-VDIM-P (TYPE III [3])

ISOCANDELA PLOT

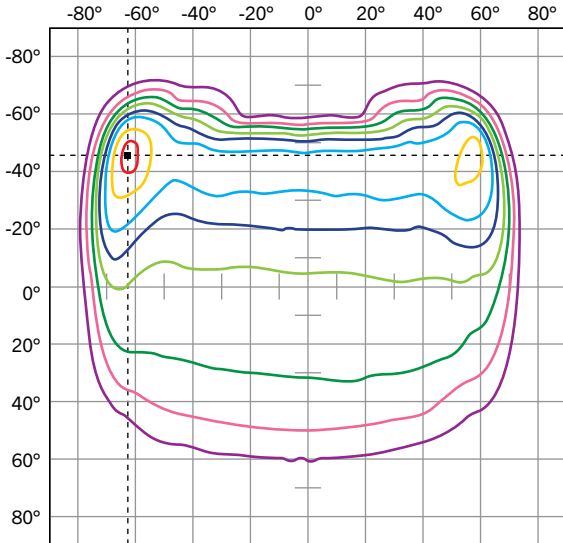

- Point of Max Cd: 11595.9
- Cd: 10278, 90%
- Cd: 8565, 75%
- Cd: 6852, 60%
- Cd: 5710, 50%
- Cd: 4568, 40%
- Cd: 3426, 30%
- Cd: 2284, 20%
- Cd: 1142, 10%

POLAR CANDELA DISTRIBUTION

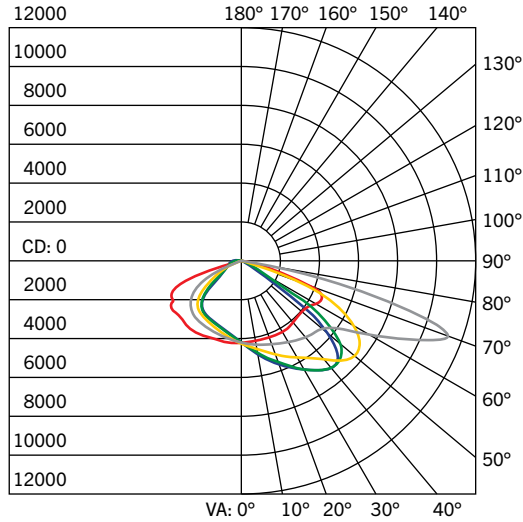

- : 0° H
- : 22.5° H
- : 67.5° H
- : 90° H
- : 45° H

FLUX DISTRIBUTION

Zone	Lumens	% Luminaire
Forward Light		
0°-30°	2171.9	11.5%
30°-60°	6942.9	36.9%
60°-80°	3378.3	17.9%
80°-90°	65.9	0.4%
Back Light		
0°-30°	1621.8	8.6%
30°-60°	3565.3	18.9%
60°-80°	1049.9	5.6%
80°-90°	36.4	0.2%
Up Light		
90°-100°	0.0	0.0%
100°-180°	0.0	0.0%
Total	18832.4	100.0%
BUG Rating	B3-U0-G3	



KT-ALEDXXXPS-X2-OSB-PMA-8CSB-VDIM-P-X

POLE MOUNTED LED AREA LIGHT PREMIUM PACKAGE

PHOTOMETRIC SPECIFICATIONS KT-ALED140PS-M2-OSB-PMA-8CSB-VDIM-P (TYPE IV [4])

ISOCANDELA PLOT

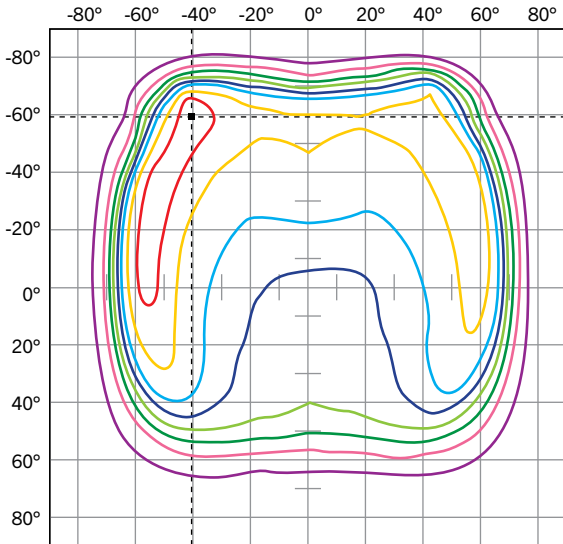

- Point of Max Cd: 7219.1
- Cd: 6400, 90%
 - Cd: 2844, 40%
 - Cd: 5333, 75%
 - Cd: 4267, 60%
 - Cd: 1422, 20%
 - Cd: 3556, 50%
 - Cd: 711, 10%

POLAR CANDELA DISTRIBUTION

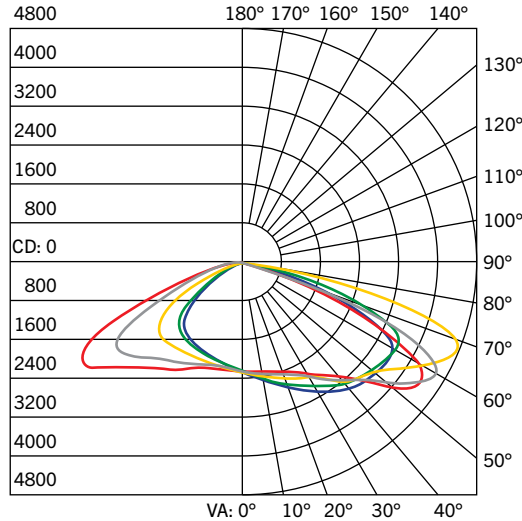

- : 0° H
- : 22.5° H
- : 67.5° H
- : 90° H
- : 45° H

FLUX DISTRIBUTION

Zone	Lumens	% Luminaire
Forward Light		
0°-30°	1628.1	8.8%
30°-60°	5903.8	32.1%
60°-80°	3949.0	21.4%
80°-90°	152.1	0.8%
Back Light		
0°-30°	1411.5	7.7%
30°-60°	4065.2	22.1%
60°-80°	1269.2	6.9%
80°-90°	35.3	0.2%
Up Light		
90°-100°	0.0	0.0%
100°-180°	0.0	0.0%
Total	18414.2	100.0%
BUG Rating	B3-U0-G3	

PHOTOMETRIC SPECIFICATIONS KT-ALED140PS-M2-OSB-PMA-8CSB-VDIM-P (TYPE V [5])

ISOCANDELA PLOT

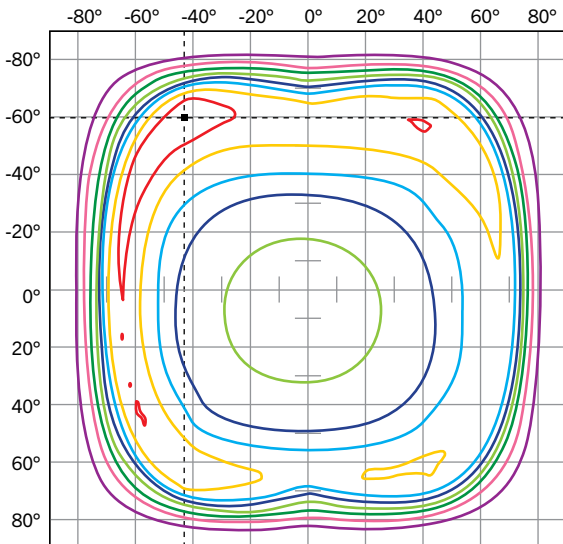

- Point of Max Cd: 6268.6
- Cd: 5608, 90%
 - Cd: 2492, 40%
 - Cd: 4673, 75%
 - Cd: 3739, 60%
 - Cd: 1246, 20%
 - Cd: 3116, 50%
 - Cd: 623, 10%

POLAR CANDELA DISTRIBUTION

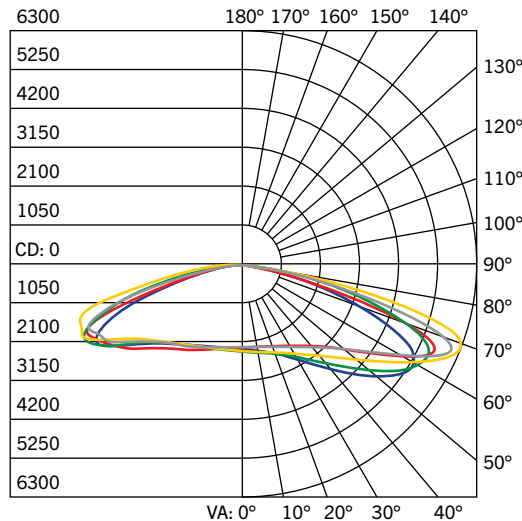

- : 0° H
- : 22.5° H
- : 67.5° H
- : 90° H
- : 45° H

FLUX DISTRIBUTION

Zone	Lumens	% Luminaire
Forward Light		
0°-30°	1056.8	5.6%
30°-60°	4393.8	23.3%
60°-80°	4321.3	23.0%
80°-90°	233.7	1.2%
Back Light		
0°-30°	995.5	5.3%
30°-60°	3593.6	19.1%
60°-80°	3986.6	21.2%
80°-90°	238.8	1.3%
Up Light		
90°-100°	0.0	0.0%
100°-180°	0.0	0.0%
Total	18820.1	100.0%
BUG Rating	B4-U0-G3	



KT-ALEDXXXPS-X2-OSB-PMA-8CSB-VDIM-P-X

POLE MOUNTED LED AREA LIGHT PREMIUM PACKAGE

PHOTOMETRIC SPECIFICATIONS KT-ALED290PS-L2-OSB-PMA-8CSB-VDIM-P (TYPE II [2])

ISOCANDELA PLOT

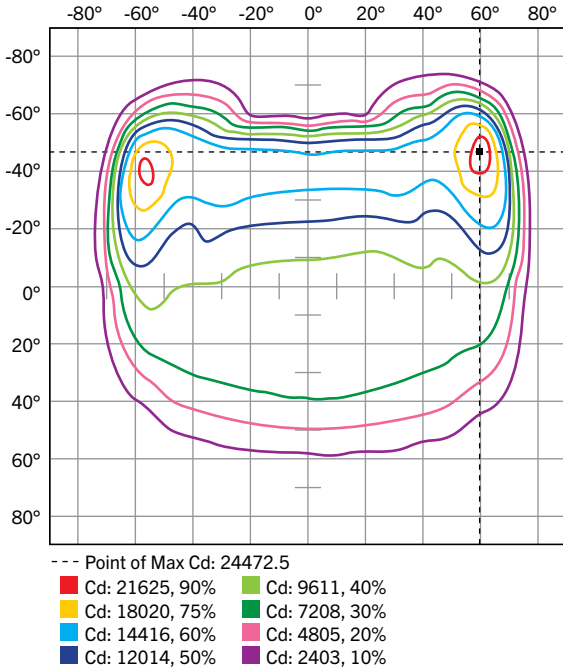

POLAR CANDELA DISTRIBUTION

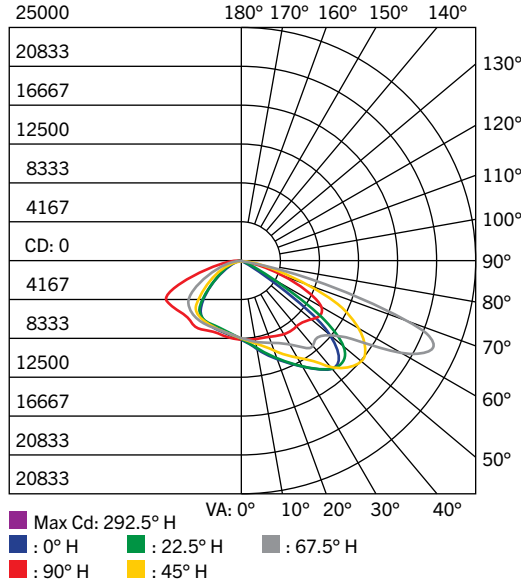

FLUX DISTRIBUTION

Zone	Lumens	% Luminaire
Forward Light		
0°-30°	4351.7	10.9%
30°-60°	14745.1	37.0%
60°-80°	7342.5	18.4%
80°-90°	181.0	0.5%
Back Light		
0°-30°	3433.4	8.6%
30°-60°	7633.2	19.2%
60°-80°	2037.6	5.1%
80°-90°	76.3	0.2%
Up Light		
90°-100°	0.0	0.0%
100°-180°	0.0	0.0%
Total	39800.8	100.0%
BUG Rating	B4-U0-G3	

PHOTOMETRIC SPECIFICATIONS KT-ALED290PS-L2-OSB-PMA-8CSB-VDIM-P (TYPE III [3])

ISOCANDELA PLOT

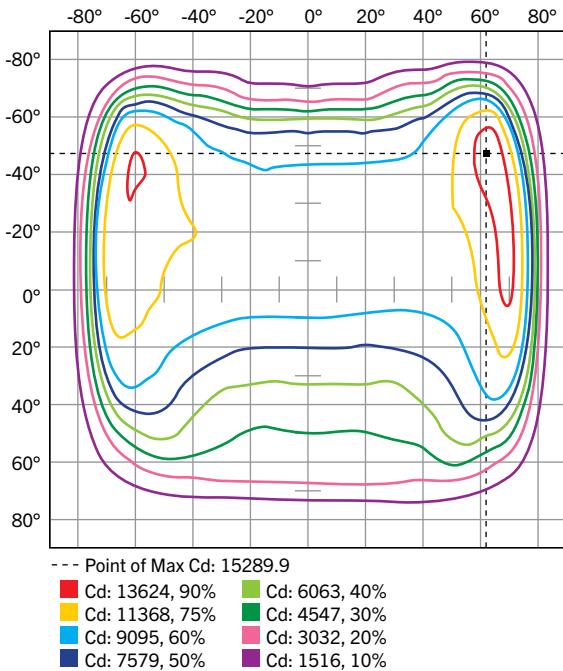

POLAR CANDELA DISTRIBUTION

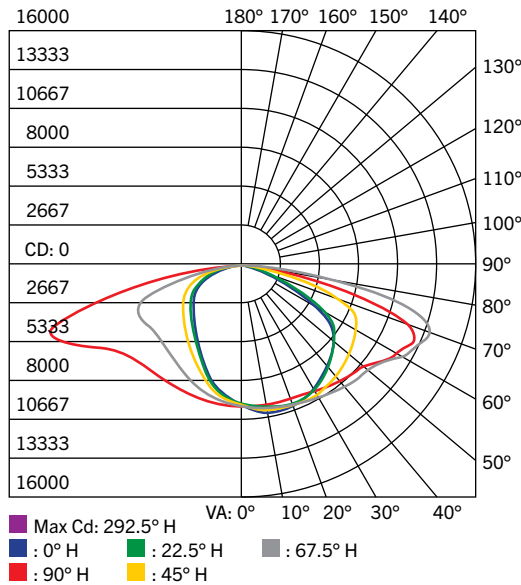

FLUX DISTRIBUTION

Zone	Lumens	% Luminaire
Forward Light		
0°-30°	4375.3	11.0%
30°-60°	11377.5	38.6%
60°-80°	7372.5	18.6%
80°-90°	503.8	1.3%
Back Light		
0°-30°	3570.4	9.0%
30°-60°	7690.4	19.4%
60°-80°	4636.1	11.7%
80°-90°	200.5	0.5%
Up Light		
90°-100°	0.0	0.0%
100°-180°	0.0	0.0%
Total	39726.5	100.0%
BUG Rating	B4-U0-G4	



KT-ALEDXXXPS-X2-OSB-PMA-8CSB-VDIM-P-X

POLE MOUNTED LED AREA LIGHT PREMIUM PACKAGE

PHOTOMETRIC SPECIFICATIONS KT-ALED290PS-L2-OSB-PMA-8CSB-VDIM-P (TYPE IV [4])

ISOCANDELA PLOT

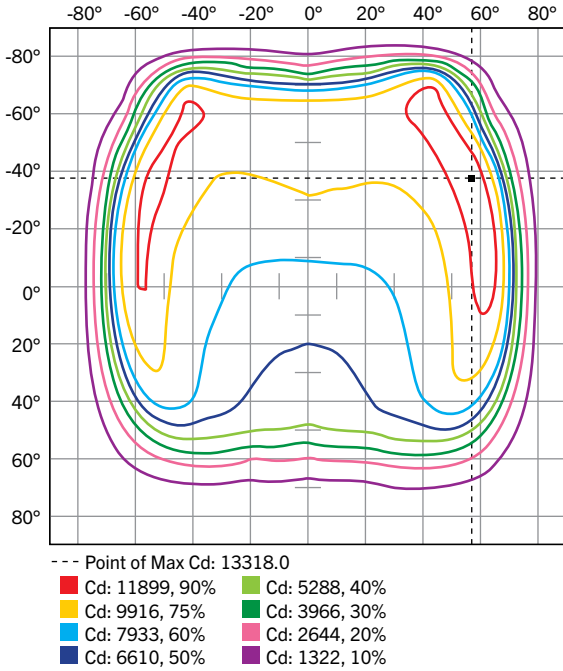

POLAR CANDELA DISTRIBUTION

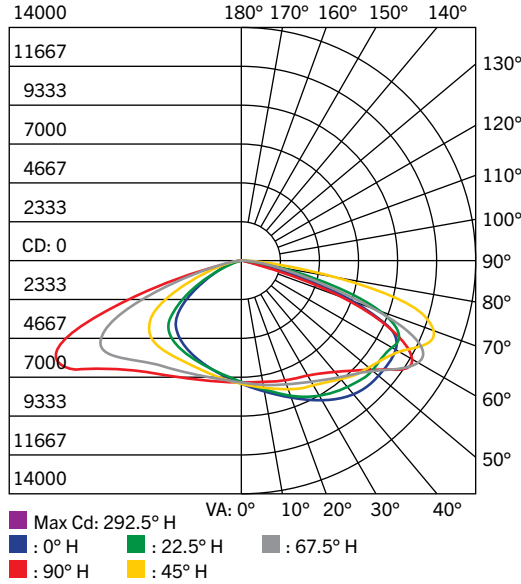

FLUX DISTRIBUTION

Zone	Lumens	% Luminaire
Forward Light		
0°-30°	3496.9	8.9%
30°-60°	11626.4	29.8%
60°-80°	8787.4	22.5%
80°-90°	518.0	1.3%
Back Light		
0°-30°	2971.1	7.6%
30°-60°	8241.1	21.1%
60°-80°	3333.1	8.5%
80°-90°	101.3	0.3%
Up Light		
90°-100°	0.0	0.0%
100°-180°	0.0	0.0%
Total	39075.3	100.0%
BUG Rating	B4-U0-G4	

PHOTOMETRIC SPECIFICATIONS KT-ALED290PS-L2-OSB-PMA-8CSB-VDIM-P (TYPE V [5])

ISOCANDELA PLOT

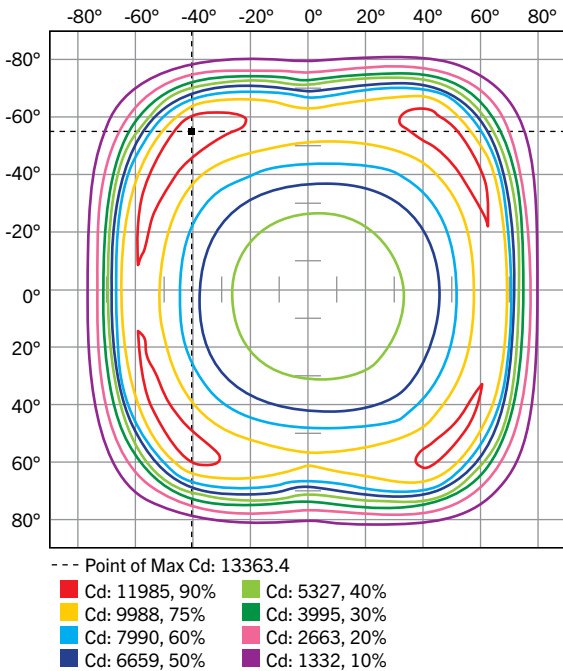

POLAR CANDELA DISTRIBUTION

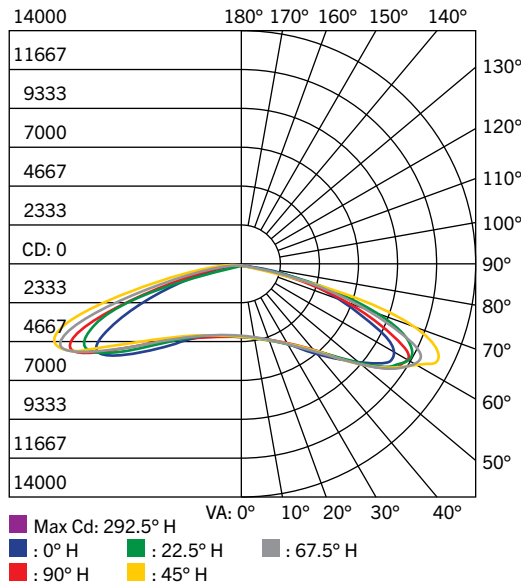

FLUX DISTRIBUTION

Zone	Lumens	% Luminaire
Forward Light		
0°-30°	2080.9	5.3%
30°-60°	9547.3	24.1%
60°-80°	8307.2	21.0%
80°-90°	338.0	0.9%
Back Light		
0°-30°	2030.2	5.1%
30°-60°	8965.1	22.7%
60°-80°	7959.9	20.1%
80°-90°	313.0	0.8%
Up Light		
90°-100°	0.0	0.0%
100°-180°	0.0	0.0%
Total	39538.6	100.0%
BUG Rating	B5-U0-G4	



KT-ALEDXXXPS-X2-OSB-PMA-8CSB-VDIM-P-X

POLE MOUNTED LED AREA LIGHT PREMIUM PACKAGE

EPA SPECIFICATIONS

MEDIUM AND LARGE-SIZE FIXTURE HOUSING

- Conditions: Horizontal winds only for calculations. Worst case total projected area used for calculations.
- All drag coefficients are set as worst case 1.2.
- For details on exact EPA calculations and assumptions, please contact productsupport@keystonetech.com

EPA Calcs (1.2*ft^2 | View)

		Single Fixture	2 Fixtures at 90°	2 Fixtures at 180°	3 Fixtures at 90°	3 Fixtures at 120°	4 Fixtures at 90°	2 Fixtures Side-by-Side	3 Fixtures Side-by-Side	4 Fixtures Side-by-Side
Mounting Application	Fixture Position									
Adjustable Pole Mount 	Horizontal (M)	0.50 sq. ft.	0.78 sq. ft.	1.01 sq. ft.	1.19 sq. ft.	1.28 sq. ft.	1.19 sq. ft.	0.74 sq. ft.	1.11 sq. ft.	1.48 sq. ft.
	Horizontal (L)	0.62 sq. ft.	0.90 sq. ft.	1.24 sq. ft.	1.42 sq. ft.	1.48 sq. ft.	1.42 sq. ft.	0.74 sq. ft.	1.11 sq. ft.	1.48 sq. ft.
Adjustable Pole Mount 	45° (M)	1.27 sq. ft.	1.73 sq. ft.	1.27 sq. ft.	2.20 sq. ft.	3.10 sq. ft.	2.20 sq. ft.	2.53 sq. ft.	3.80 sq. ft.	5.07 sq. ft.
	45° (L)	1.85 sq. ft.	2.43 sq. ft.	1.85 sq. ft.	3.01 sq. ft.	4.42 sq. ft.	3.01 sq. ft.	3.70 sq. ft.	5.55 sq. ft.	7.40 sq. ft.



KT-ALEDXXXPS-X2-OSB-PMA-8CSB-VDIM-P-X

POLE MOUNTED LED AREA LIGHT PREMIUM PACKAGE

ACCESSORIES (SOLD SEPARATELY)

SENSORS

Factory-Installable OR Field-Installable (field-installable purchased separately)

✓	SUFFIX*	CATALOG NUMBER	DESCRIPTION	UPC	EASY CODE
	/MW3	KTS-MW3-12V-PKO	12V Microwave Occupancy Sensor	843654130637	TRM-32
	/FC3**	KTSL-FC3-12V-PKO-PIR	Bluetooth mesh wireless screw-in LED controller for SmartLoop system Integrated daylight sensor PIR motion sensor	843654138862	OCW-60
	/FC4	KTSL-FC4-12V-PKO	Bluetooth mesh wireless screw-in low voltage fixture controller for SmartLoop system	843654149066	RUN-10



* For factory installation of accessory, add suffix to fixture part number (see ordering examples and instructions on last page of spec sheet).
 ** When installing on Keystone area lights, use small thin gasket provided with the sensor to ensure proper electrical connection and a water-tight seal. Hand tighten only. (Do NOT use the larger thick gasket. Sensor will not make electrical contact with thick gasket.) PIR sensors may not always perform reliably in typical outdoor environments. Ensure sensors are used and commissioned with this in mind. Consult Keystone for further information on the matter. When using KTSL-FC3-12V-PKO-PIR in applications with photosensor control for dusk to dawn, use 3-pin twist-lock photocells (KT-TLP-UV-3P) for optimal functionality.

Field-Installable / Field-Use ONLY (purchased separately)

CATALOG NUMBER	DESCRIPTION	UPC	EASY CODE
KTS-MW3-REMOTECONTROL	Remote control for KTS-MW3-12V-XX Sensors Sets and adjusts all sensor performance parameters	843654132020	XSR-61



SURGE PROTECTORS

Factory-Installable OR Field-Installable (field-installable purchased separately)

CATALOG NUMBER	DESCRIPTION	UPC	EASY CODE
KTSP-10KV-C	External surge protector Compact design	843654129204	BUU-26





KT-ALEDXXXPS-X2-OSB-PMA-8CSB-VDIM-P-X

POLE MOUNTED LED AREA LIGHT PREMIUM PACKAGE

ACCESSORIES CONTINUED (SOLD SEPARATELY)

LENSES

Field-Installable / Field-Use ONLY (purchased separately)

CATALOG NUMBER	DESCRIPTION	UPC	EASY CODE
KT-ALED-LENS-M2-2CS-KIT	Type II optics lens Used on Series 2 area lights Medium size Color Select	843654153933	ICD-51
KT-ALED-LENS-L2-2CS-KIT	Type II optics lens Used on Series 2 area lights Large size Color Select	843654153858	HXC-12

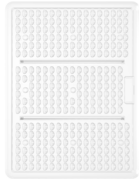

Lenses
KT-ALED-LENS-M2-2CS-KIT

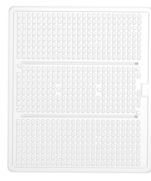

Lenses
KT-ALED-LENS-L2-2CS-KIT

MOUNTS AND BRACKETS

Field-Installable / Field-Use ONLY (purchased separately)

CATALOG NUMBER	DESCRIPTION	UPC	EASY CODE
KT-ALED-GS-M2-KIT	Reversible glare shield Medium size Bronze	843654153797	HEM-55
KT-ALED-GS-L2-KIT	Reversible glare shield Large size Bronze	843654153810	RDW-18
KT-ALED-GS-M2-R-KIT	Right-side mounted glare shield Medium size Bronze	843654163895	OYO-78
KT-ALED-GS-M2-L-KIT	Left-side mounted glare shield Medium size Bronze	843654163901	GLB-48
KT-ALED-GS-L2-R-KIT	Right-side mounted glare shield Large size Bronze	843654163871	KAV-10
KT-ALED-GS-L2-L-KIT	Left-side mounted glare shield Large size Bronze	843654163888	PND-07
KT-ALED-GS-M2-KIT-W	Reversible glare shield Medium size White	843654153803	GMR-48
KT-ALED-GS-L2-KIT-W	Reversible glare shield Large size White	843654153827	DQV-16
KT-ALED-GS-M2-R-KIT-W	Right-side mounted glare shield Medium size White	843654163956	ZNJ-03
KT-ALED-GS-M2-L-KIT-W	Left-side mounted glare shield Medium size White	843654163963	PUC-94
KT-ALED-GS-L2-R-KIT-W	Right-side mounted glare shield Large size White	843654163932	RBJ-14
KT-ALED-GS-L2-L-KIT-W	Left-side mounted glare shield Large size White	843654163949	SQW-90
KT-ALED-WM-1-KIT	Wall mount Bronze	843654158952	QCV-37
KT-ALED-WM-1-KIT-W	Wall mount White	843654158969	RBE-23



Reversible Glare Shield
KT-ALED-GS-M2-KIT



Left-Side Glare Shield
KT-ALED-GS-M2-L-KIT



Right-Side Glare Shield
KT-ALED-GS-M2-R-KIT



Wall Mount Kit
KT-ALED-WM-1-KIT

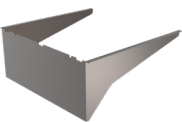

Reversible Glare Shield
KT-ALED-GS-L2-KIT



Left-Side Glare Shield
KT-ALED-GS-L2-L-KIT

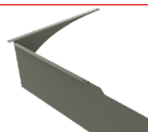

Right-Side Glare Shield
KT-ALED-GS-L2-R-KIT

Note: Wall mount adaptor must be used with adjustable or fixed pole mounts

(Accessories continued on next page)



KT-ALEDXXXPS-X2-OSB-PMA-8CSB-VDIM-P-X

POLE MOUNTED LED AREA LIGHT PREMIUM PACKAGE

ACCESSORIES CONTINUED (SOLD SEPARATELY)



Note: Wall mount adaptor must be used with adjustable or fixed pole mounts

ORDERING INFORMATION

ORDER CODE	UPC	Easy Code	DLC PRODUCT ID
KT-ALED140PS-M2-OSB-PMA-8CSB-VDIM-P	843654153087	WEN-81	S-3M8BUZ
KT-ALED140PS-M2-OSB-PMA-8CSB-VDIM-P-W	843654153094	GJJ-95	
KT-ALED290PS-L2-OSB-PMA-8CSB-VDIM-P	843654153124	LWD-80	S-YHAT2Q
KT-ALED290PS-L2-OSB-PMA-8CSB-VDIM-P-W	843654153131	WOC-65	

CATALOG NUMBER BREAKDOWN

KT-ALEDXXXPS-X2-OSB-PMA-8CSB-VDIM-P-X

1	2	3	4	5	6	7	8	9	10	11	12	13	14	15	16
1 Keystone Technologies	2 Fixture Type	3 LED Technology	4 Max Wattage	5 Power Select	6 Size / Shape	7 Style / Design Designation	8 Optic Swap	9 Optic Swap Designation	10 Pole Mount Adjustable	11 80 CRI	12 Color Select	13 Color Select Designation	14 0-10V Dimming	15 Stock Package	16 Housing Color
			140 140W		M Medium			B Type III lens installed, Type IV and V lens included				B 3000/4000/5000K			
			290 290W		L Large										W White

ORDERING EXAMPLES

FIXTURE WITH SINGLE FACTORY-INSTALLED ACCESSORY

KT-ALED140PS-M2-OSB-PMA-8CSB-VDIM-P /FC3

FIXTURE WITH NO FACTORY-INSTALLED ACCESSORIES

KT-ALED140PS-M2-OSB-PMA-8CSB-VDIM-P

KEYSTONE FIXTURE

CATALOG NUMBER

KT-ALED140PS-M2-OSB-PMA-8CSB-VDIM-P

SENSORS

✓	SUFFIX	CATALOG NUMBER
✓	/FC3	KTSL-FC3-12V-PKO-PIR

*When ordering more than one factory-installed accessory, use multiple suffixes as shown in the ordering examples above.

Note: All accessories can also be ordered separately for field installation using just their regular Catalog Number, UPC, or Easy Code.