

KT-MSLED25PS-2-8CSA-VDIM

MICROSTRIP FIXTURE

DESCRIPTION

2' LED Microstrip Fixture | 120 – 277V Input |
Frosted Lens | 0 – 10V Dimming

APPLICATION

Used for commercial, retail, and residential strip applications



PRODUCT FEATURES

- Features Keystone Power Select technology (25/20/15W). Adjust power between 25/20/15W, changing lumen output to set high end trim.
- Features Keystone Color Select technology (3500/4000/5000K)
- Luminaire is suitable for installation within a clothes closet storage space.
- Powered by Keystone 0 – 10V dimming LED drivers
- Post-painted steel body; PMMA lens
- Compatible with Keystone occupancy sensors
- Ambient operating temperature: -20°C/-4°F to 50°C/122°F
- UL Listed 1598: Suitable for dry and damp locations
- THD: < 20%
- Power factor > 0.95

POWER AND COLOR TEMPERATURE SELECTABILITY

- Keystone Color Select Technology: Adjustable CCT (3500K/4000K/5000K)
- Keystone Power Select Technology: Adjustable Wattage (25W/20W/15W)

PRODUCT SPECIFICATIONS

Catalog Number	Input Voltage	Wattage	CCT	Lumen Output	Efficacy	CRI	Power Factor	Lifetime
KT-MSLED25PS-2-8CSA-VDIM	120–277V	25W	3500K	3,250	130 lm/W	> 80	> 0.90	50,000 hrs
			4000K	3,275	131 lm/W			
			5000K	3,300	132 lm/W			
		20W	3500K	2,720	136 lm/W			
			4000K	2,740	137 lm/W			
			5000K	2,760	138 lm/W			
		15W	3500K	2,085	139 lm/W			
			4000K	2,100	140 lm/W			
			5000K	2,115	141 lm/W			

ONE CATALOG NUMBER WITH 9 DIFFERENT OPTIONS

* Preset to highest lumen output (25W / 5000K)
* Color Uniformity: CCT (Correlated Color Temperature) range as per guidelines outlined in ANSI C78.377-2017.

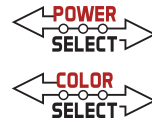

KT-MSLED25PS-2-8CSA-VDIM

MICROSTRIP FIXTURE

PHOTOMETRIC SPECIFICATIONS

ISOCANDELA PLOT

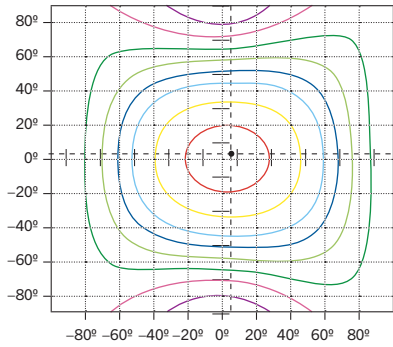

- Cd: 891, 90%
 - Cd: 743, 75%
 - Cd: 594, 60%
 - Cd: 495, 50%
 - Cd: 396, 40%
 - Cd: 297, 30%
 - Cd: 198, 20%
 - Cd: 99, 10%
- Point of Max Cd: 990.5

POLAR CANDELA DISTRIBUTION

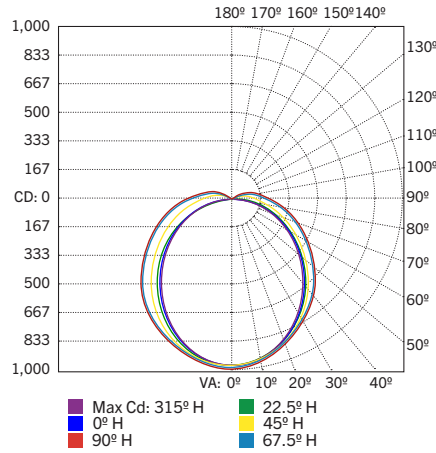

- Max Cd: 315° H
- 0° H
- 90° H
- 22.5° H
- 45° H
- 67.5° H

ZONAL LUMEN SUMMARY

Zone	Lumens	% Luminaire
0-60	2,215.2	65.40%
60-90	884.3	26.10%
0-90	3,099.5	91.50%
90-180	289.5	8.50%
0-180	3,389.0	100.0%

PHYSICAL SPECIFICATIONS

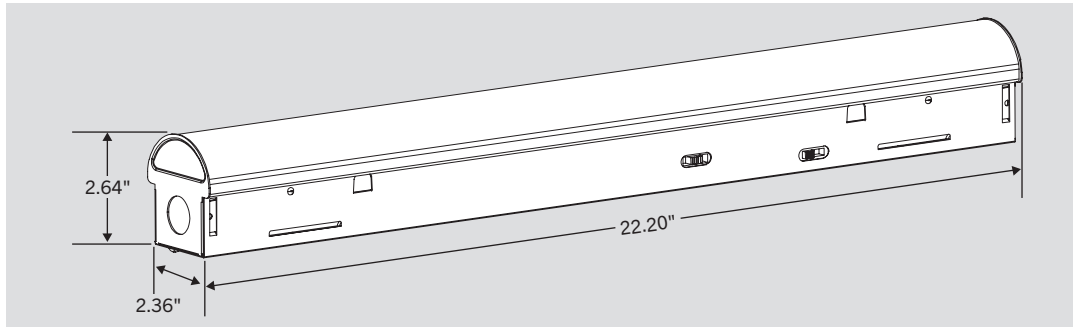

WIRING DIAGRAMS

0-10V Dimmer

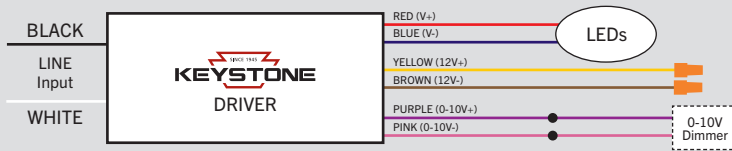

KTSL-FC2-12V-SM-PIR Fixture Controller/Sensor and other 12V powered 0-10V sensors

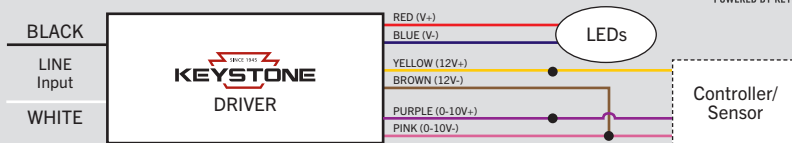

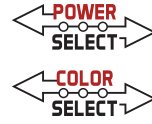

KT-MSLED25PS-2-8CSA-VDIM

MICROSTRIP FIXTURE

ACCESSORIES

SENSORS

Factory-Installable OR Field-Installable (field-installable purchased separately)

✓	SUFFIX*	CATALOG NUMBER	DESCRIPTION	UPC	EASY CODE
	/PIR	KTS-PIR2-UV-KO	High Bay PIR Motion Sensor, 120-347V Input. Adjustable Standby Dim level, Hold Times & Daylight Threshold controls. Fixture Mount via 1/2 inch KO	843654123288	IOF-04
	/MW	KTS-MW3-UV-KO-K2	Microwave Sensor Kit, Includes 120-277V input to 12V DC convertor, IP65 12V input sensor head, Nomex Sleeve, Extension Neck. Bi-Level Control with Adjustable Hold Time, Dim Level and Standby Time. Installs via standard 1/2in KO	843654134352	TBV-76
	/FC2	KTSL-FC2-12V-SM-PIR	Bluetooth mesh wireless low voltage individual fixture controller for SmartLoop system with integrated daylight and PIR motion sensors, 12V, 0-10V Dimming	843654135236	TCM-01
	/HBFC1	KTSL-HBFC1-UV-KO-PIR	Bluetooth mesh Wireless Fixture Controller for SmartLoop System with integrated daylight and PIR motion sensor. 120-277V. 3A Max Load with 0-10V Dimming	 843654129266	AEJ-50



Smart Loop PIR Sensor
KTSL-HBFC1-UV-KO-PIR



Fixture installed with KTSL-FC2-12V-SM-PIR
and KT-MSLED-SLB-1 bracket

* FOR FACTORY INSTALLATION OF ACCESSORY, ADD SUFFIX TO FIXTURE PART NUMBER (SEE ORDERING EXAMPLES AND INSTRUCTIONS ON LAST PAGE OF SPEC SHEET).

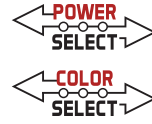

KT-MSLED25PS-2-8CSA-VDIM

MICROSTRIP FIXTURE

ACCESSORIES (continued)

CORD SETS

Factory-Installable OR Field-Installable (field-installable purchased separately)

✓	SUFFIX*	CATALOG NUMBER	DESCRIPTION	UPC	EASY CODE
	/515P6	KT-CS-515P-6-18/3	Cord set; 125V NEMA 5-15P; straight blade plug ;6' SJTOW cable; 18/3 wire	843654140124	UKH-26
	/L715P10	KT-CS-L715P-10-16/3	Cord set; 277V NEMA L7-15P; twist lock plug; 10' SJTOW cable; 16/3 wire	843654140131	SFV-88
	/L615P10	KT-CS-L615P-10-16/3	Cord set; 250V NEMA L6-15P; twist lock plug; 10' SJTOW cable; 16/3 wire	843654140148	ZQS-05
	/L515P10	KT-CS-L515P-10-16/3	Cord set; 250V NEMA L5-15P; twist lock plug; 10' SJTOW cable; 16/3 wire	843654140155	GVH-22
	/L715P6	KT-CS-L715P-6-16/3	Cord set; 277V NEMA L7-15P; twist lock plug; 6' SJTOW cable; 16/3 wire	843654140162	DVU-44
	/L615P6	KT-CS-L615P-6-16/3	Cord set; 250V NEMA L6-15P; twist lock plug; 6' SJTOW cable; 16/3 wire	843654140179	LCW-66
	/L515P6	KT-CS-L515P-6-16/3	Cord set; 250V NEMA L5-15P; twist lock plug; 6' SJTOW cable; 16/3 wire	843654140186	POC-82
	/NP10	KT-CS-NP-10-16/3	Cord; no plug; inners 1/2" strip on both ends; 10' SJTOW cable; 16/3 wire	843654140193	YOH-90
	/NP6	KT-CS-NP-6-16/3	Cord; no plug; inners 1/2" strip on both ends; 6' SJTOW cable; 16/3 wire	843654140216	HUB-73
	/NP15	KT-CS-NP-15-16/3	Cord; no plug; inners 1/2" strip on both ends; 15' SJTOW cable; 16/3 wire	843654140209	EYD-18



Cord Sets

* FOR FACTORY INSTALLATION OF ACCESSORY, ADD SUFFIX TO FIXTURE PART NUMBER (SEE ORDERING EXAMPLES AND INSTRUCTIONS ON LAST PAGE OF SPEC SHEET).
NOTE: FOR CORD SETS NOT LISTED HERE, PLEASE CONTACT YOUR KEYSTONE SALES REP.

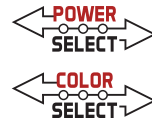

KT-MSLED25PS-2-8CSA-VDIM

MICROSTRIP FIXTURE

ACCESSORIES (continued)

MOUNTS AND BRACKETS

Field-Installable / Field-Use **ONLY** (purchased separately)

CATALOG NUMBER	DESCRIPTION	UPC	EASY CODE
KT-MSLED-VH-KIT	V-Hook and Chain Kit for Keystone Micro LED Strip fixtures. Includes (2) V-Hooks and (2) chains 40in long	843654121031	YAK-04
KT-MSLED-SLB-1	Microstrip Bracket for Smart Loop KTSL-FC2-12V-SM-PIR Sensor	843654135472	GGU-95
KT-MSLED-LSM-KIT	Linking Surface Mount Kit for MSLED fixtures. Includes End to End Metal bracket and KO grommet	843654126883	BCV-03

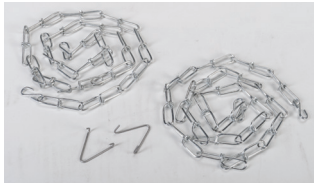

V-Hook and Chain Kit
KT-MSLED-VH-KIT

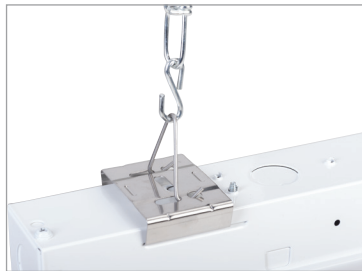

Linking Surface Mount Kit
KT-MSLED-LSM-KIT

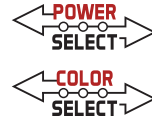

KT-MSLED25PS-2-8CSA-VDIM

MICROSTRIP FIXTURE

ORDERING INFORMATION

Catalog Number	Pack Quantity	Easy Code	UPC
KT-MSLED25PS-2-8CSA-VDIM	TBD	MTU-40	843654134895

CATALOG NUMBER BREAKDOWN

KT-MSLED25PS-2-8CSA-VDIM

- 1
- 2
- 3
- 4
- 5
- 6
- 7
- 8
- 9

- 1 Keystone Technologies
- 2 LED Microstrip Fixture
- 3 Wattage
- 4 Power Select
- 5 2' Nominal Length
- 6 80 CRI
- 7 Color Select
- 8 Color Select Designation
- 9 0–10V Dimming

8 Color Select Designation

A	3500K, 4000K, 5000K
---	---------------------

ORDERING EXAMPLES

FIXTURE WITH MULTIPLE FACTORY-INSTALLED ACCESSORIES*

KT-MSLED25PS-2-8CSA-VDIM /PIR /NP10 /VH

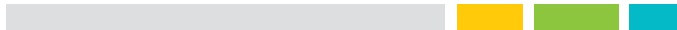

FIXTURE WITH TWO FACTORY-INSTALLED ACCESSORIES*

KT-MSLED25PS-2-8CSA-VDIM /PIR /NP10

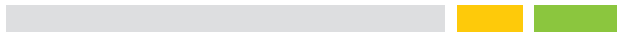

FIXTURE WITH SINGLE FACTORY-INSTALLED ACCESSORY

KT-MSLED25PS-2-8CSA-VDIM /PIR

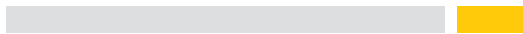

FIXTURE WITH NO FACTORY-INSTALLED ACCESSORIES

KT-MSLED25PS-2-8CSA-VDIM

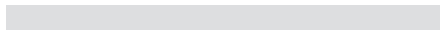

KEYSTONE FIXTURE

CATALOG NUMBER
KT-MSLED25PS-2-8CSA-VDIM

SENSORS

✓	SUFFIX	CATALOG NUMBER
✓	/PIR	KTS-PIR2-UV-KO

CORD SETS

✓	SUFFIX	CATALOG NUMBER
✓	/NP10	KT-CS-NP-10-16/3

MOUNTS AND BRACKETS

✓	SUFFIX	CATALOG NUMBER
✓	/VH	KT-MSLED-VH-KIT

* WHEN ORDERING MORE THAN ONE FACTORY-INSTALLED ACCESSORY, USE MULTIPLE SUFFIXES AS SHOWN IN THE ORDERING EXAMPLES ABOVE.
 NOTE: ALL ACCESSORIES CAN ALSO BE ORDERED SEPARATELY FOR FIELD INSTALLATION USING JUST THEIR REGULAR CATALOG NUMBER, UPC, OR EASY CODE.