

SCM SLIM CANOPY 10"x10"

DESCRIPTION

naturaLED® SCM IP65 rated fixtures come in an aesthetically pleasing construction, low-profile design with die-cast aluminum housing and shatter-resistant polycarbonate prismatic lens. In addition, they are dust-proof and include 1/2" threaded conduit entrances on each side. The SCM fixtures are available with or without a microwave occupancy sensor mounted behind the lens. This sensor has multiple settings that can be selected via a dip switch. The settings on the sensor include: step dimming, area sensitivity, standby time and on/off. The SCM supports both pendant mounting and direct surface mounting ceiling or wall. Pendant mounting accepts a 3/4" NPT thread and can be mounted to multiple types of J-boxes.

APPLICATIONS

Warehouses, Parking Garages, Offices, Factories, Hospitals, Hotels







FEATURES

- DLC Premium Qualified
- IP65 Rated
- ETL Listed
- ColorTemp: 4000K, 5000K
- Voltage: 120-277V
- Powerfactor >0.9
- Surge Protection: 4KV
- Beam Angle: 160°
- Dimmable: 1-10V
- CRI: 80
- Operating temperature: - 40°F - 122°F
- Long life LED chips
- Material: aluminum die-cast
- Colors: Black /White
- 5 Year Warranty
- Optional for purchase: Emergency Driver, Drop/Frosted Lens, Photocell, Motion Sensor, Surge Protector, Beauty Plates



Rated Life 50,000 Hours
Warranty 5 Years

ACCESSORIES

	Emergency Driver
	Motion Sensor
	Beauty Plate
	Drop Lens
	Frosted Lens
	Surge Protector
	Photocell

SAMPLE NUMBER FX10SCM28/840/BK-SEN

FAMILY	SIZE	SERIES	WATTAGE	CRI/COLOR TEMP	COLOR	ACCESSORY
FX	10	SCM	28	840	BK	SEN
Fixture	10-inch	Slim Canopy	28 Watt	CRI 80 4000K	Black (WH) White	Motion Sensor none N/A



SLIM CANOPY 10X10

CEILING & AREA LUMINAIRES

ORDERING

*P= Premium DLC / *S = Standard DLC

	Watts (W)	Ordering Code	Description	CCT (K)	Lumens (Lm)	Equiv. Wattage (W)	Dim (V)	Color	Sensor	IP65 Rated	DLC (S/P)
Motion Sensor	28	9432	FX10SCM28/840/BK-SEN	4000K	3,640	150	1-10V	Black	•	•	P
	28	9433	FX10SCM28/850/BK-SEN	5000K	3,640	150	1-10V	Black	•	•	P
	42	9434	FX10SCM42/840/BK-SEN	4000K	5,517	175	1-10V	Black	•	•	P
	42	9435	FX10SCM42/850/BK-SEN	5000K	5,638	175	1-10V	Black	•	•	P
	59	9436	FX10SCM59/840/BK-SEN	4000K	7,695	250	1-10V	Black	•	•	P
	59	9437	FX10SCM59/850/BK-SEN	5000K	7,845	250	1-10V	Black	•	•	P
	28	9414	FX10SCM28/840/BK	4000K	3,640	150	1-10V	Black	-	•	P
	28	9415	FX10SCM28/850/BK	5000K	3,640	150	1-10V	Black	-	•	P
	42	9418	FX10SCM42/840/BK	4000K	5,517	175	1-10V	Black	-	•	P
	42	9419	FX10SCM42/850/BK	5000K	5,638	175	1-10V	Black	-	•	P
	59	9422	FX10SCM59/840/BK	4000K	7,695	250	1-10V	Black	-	•	P
	59	9423	FX10SCM59/850/BK	5000K	7,845	250	1-10V	Black	-	•	P
	28	9416	FX10SCM28/840/WH	4000K	3,640	150	1-10V	White	-	•	P
	28	9417	FX10SCM28/850/WH	5000K	3,640	150	1-10V	White	-	•	P
	42	9420	FX10SCM42/840/WH	4000K	5,517	175	1-10V	White	-	•	P
	42	9421	FX10SCM42/850/WH	5000K	5,638	175	1-10V	White	-	•	P
	59	9424	FX10SCM59/840/WH	4000K	7,695	250	1-10V	White	-	•	P
	59	9425	FX10SCM59/850/WH	5000K	7,845	250	1-10V	White	-	•	P

ACCESSORIES (Ordered Separately)

Motion Sensor



P10234 SEN-MC605V-D
(Microwave Motion Sensor 0-10V)

Emergency Driver



7336 BAEM4-60BC/MV-A
(Emergency Driver for 28W & 42W)

Photocell



P10036 SEN-PHO-BT-MT/MV
(Button Photocell 120V-277)

Beauty Plates



P10195 PLT-SCM/14X14/WH
(14"x14" Beauty Plate used with SCM)

P10196 PLT-SCM/24X24/WH
(24"x24" Beauty Plate used with SCM)

Frosted Lens



P10125 LENS-SCM/FR9X9
(Frosted Lens for SCM 28W, 42W, 59W)

Drop Lens



P10126 LENS-SCM/DR9X9
(Drop Lens for SCM 28W, 42W, 59W)

Surge Protector



P10389 SPD-L-10KV-277
(Surge Protection 10KV 120-277V)



P10390 SPD-L-20KV-277
(Surge Protection 20KV 120-277V)



P10391 SPD-L-20KV-480
(Surge Protection 20KV 347-480V)

DIMENSIONS

28W **42W** **59W**
4.50-lbs 5.10-lbs 5.10-lbs

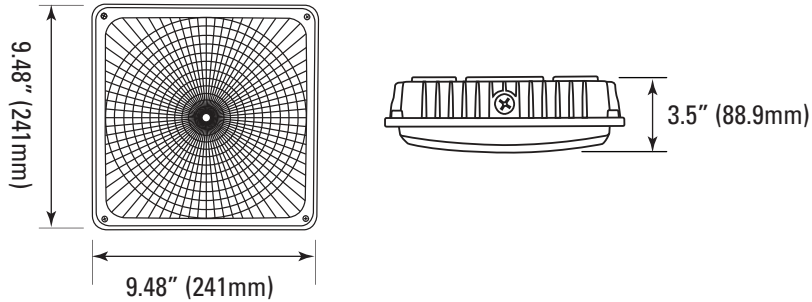

PHOTOMETRICS CHART

28 Watt
DLC Premium

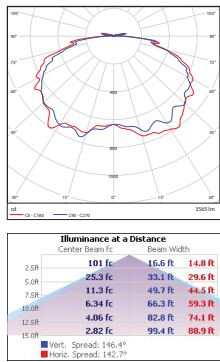

42 Watt
DLC Premium

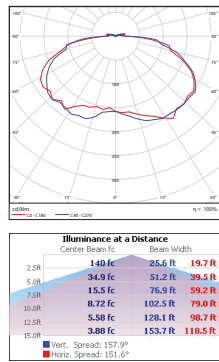

59 Watt
DLC Premium

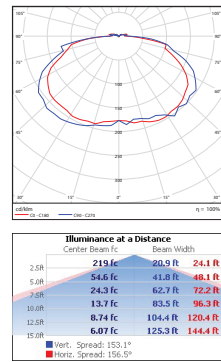

28 Watt with sensor
DLC Premium

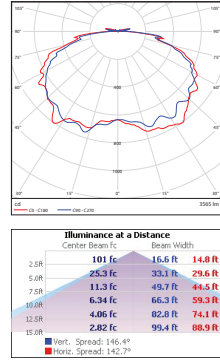

42 Watt with sensor
DLC Premium

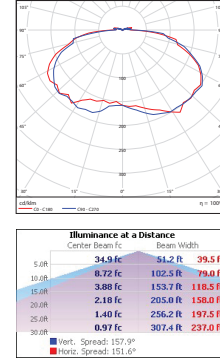

59 Watt with sensor
DLC Premium

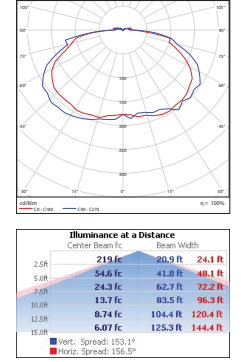

PACKAGE

Case Qty 1 pc

