



## LED LUMINAIRES

# ProLED<sup>®</sup> ProLED Downlight Retrofit Series



The ProLED Downlight Retrofit Series offers a high performance but cost efficient solution to replace traditional incandescent or compact fluorescent recessed downlighting. The High quality aluminum baffled trim design reduces glare and adds depth for upgrading the look and feel of residential downlight projects. High CRI paired with 85 LPW efficacy and 50,000 hour life maximizes both energy savings and quality of life for years to come. IC/ICAT and wet location ratings make the ProLED Downlight Retrofit Series the perfect solution for any room in the home.



**High Performance 85 LPW**

**High CRI >90**

**UL listed For Wet Locations**

**Adjustable Torsion Springs  
for 5" and 6" Housings**

**Baffled Trim Adds Depth  
and Reduces Glare**

**Energy Star Certified**

### **Applications:**

Kitchens  
Hallways  
Bathrooms  
Offices

### **Markets**

Light Commercial  
Residential

# ProLED Downlight Retrofit Series

## Performance

- High efficacy - 85 LPW
- High CRI >90
- L70 Lumen Maintenance > 50,000 hours 120VAC input
- Adjustable 5" - 6" torsion springs
- Available in 2700K/3000K/4000K/5000K
- Dimmable to 5%
- Meets Title 20 and Title 24-JA8 Performance requirements

## Certification

- ETL Classified 1598C Retrofit Kit
- Energy Star Certified
- Title 20 Certified
- Title 24/JA-8 Certified

## Construction

- High Quality Aluminum baffled trim
- Title 24 compliant luminaire disconnect
- E26 medium base adapter included
- Rated for IC and ICAT applications
- Suitable for wet locations

## Applications

- Residential
- Light Commercial

## Ordering Information

Product Number	Product Code	Description	Wattage	Voltage	Color Temp	CRI	Lumens	Useful Life	Dimmable	Pkg Qty	Size	Equivalent Wattage
99733	DL4FR9/927/LED3	4" Downlight Retrofit 9W Wet Location Dimmable	9	120	2700	90	765	50,000	YES	1/24	4"	65
99734	DL4FR9/930/LED3	4" Downlight Retrofit 9W Wet Location, Dimmable	9	120	3000	90	765	50,000	YES	1/24	4"	65
99735	DL4FR9/940/LED3	4" Downlight Retrofit 9W Wet Location, Dimmable	9	120	4000	90	765	50,000	YES	1/24	4"	65
99736	DL4FR9/950/LED3	4" Downlight Retrofit 9W Wet Location, Dimmable	9	120	5000	90	765	50,000	YES	1/24	4"	65
99741	DL6FR9/927/LED3	5/6" Downlight Retrofit 9W Wet Location, Dimmable	9	120	2700	90	810	50,000	YES	1/24	5/6"	75
99742	DL6FR9/930/LED3	5/6" Downlight Retrofit 9W Wet Location, Dimmable	9	120	3000	90	810	50,000	YES	1/24	5/6"	75
99743	DL6FR9/940/LED3	5/6" Downlight Retrofit 9W Wet Location, Dimmable	9	120	4000	90	810	50,000	YES	1/24	5/6"	75
99744	DL6FR9/950/LED3	5/6" Downlight Retrofit 9W Wet Location, Dimmable	9	120	5000	90	810	50,000	YES	1/24	5/6"	75
99745	DL6FR12/927/LED3	5/6" Downlight Retrofit 12.5W Wet Location, Dimmable	12.5	120	2700	90	1100	50,000	YES	1/24	5/6"	100
99746	DL6FR12/930/LED3	5/6" Downlight Retrofit 12.5W Wet Location, Dimmable	12.5	120	3000	90	1100	50,000	YES	1/24	5/6"	100
99747	DL6FR12/940/LED3	5/6" Downlight Retrofit 12.5W Wet Location, Dimmable	12.5	120	4000	90	1100	50,000	YES	1/24	5/6"	100
99748	DL6FR12/950/LED3	5/6" Downlight Retrofit 12.5W Wet Location, Dimmable	12.5	120	5000	90	1100	50,000	YES	1/24	5/6"	100
91003	ADP/DL/GU24/LED	GU24 SOCKET ADAPTER										

Please Contact a Halco Representative for more information.

\*Useful Life is defined as the point in time at which the lamp will maintain at least 70% of its initial lumens. The lamp will continue to operate past this point at decreased light levels. May not be compatible with all dimming systems, dimming performance may vary by system. Warranty - Commercial / Industrial: This product is warranted for 5 years from the date of purchase.

## Dimensions

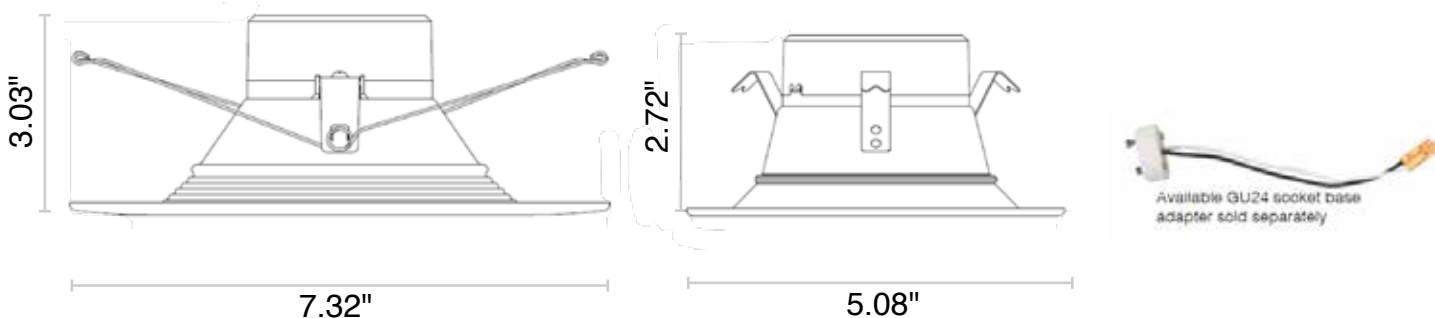

# ProLED Downlight Retrofit Series

## Photometrics

### 4" Downlight Retrofit 9W

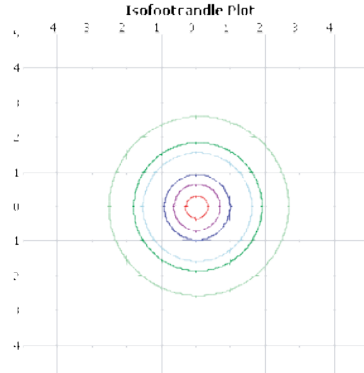
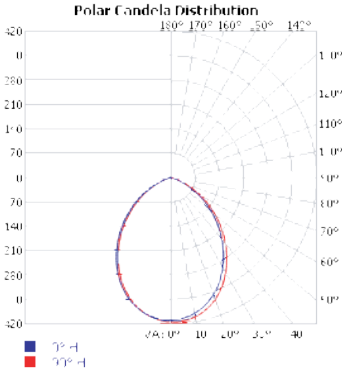

ZONAL LUMEN SUMMARY			
ZONE	LUMENS	% LAMP	% LUMINAIRE
0-30	300.1	37.5%	37.5%
0-40	468.2	58.5%	58.5%
0-60	726.6	90.8%	90.8%
60-90	73.2	9.2%	9.2%
70-100	18.4	2.3%	2.3%
90-120	0.004	0%	0%
0-90	799.8	100%	100%
90-180	0.1	0%	0%
0-180	799.9	100%	100%

LUMENS PER ZONE					
ZONE	LUMENS	% TOTAL	ZONE	LUMENS	% TOTAL
0-10	38.5	4.8%	90-100	0.000	0%
10-20	107.6	13.5%	100-110	0.000	0%
20-30	153.9	19.2%	110-120	0.004	0%
30-40	168.1	21.0%	120-130	0.0	0%
40-50	150.4	18.8%	130-140	0.0	0%
50-60	107.9	13.5%	140-150	0.0	0%
60-70	54.8	6.9%	150-160	0.0	0%
70-80	16.6	2.1%	160-170	0.0	0%
80-90	1.8	0.2%	170-180	0.004	0%

### 5/6" Downlight Retrofit 9W

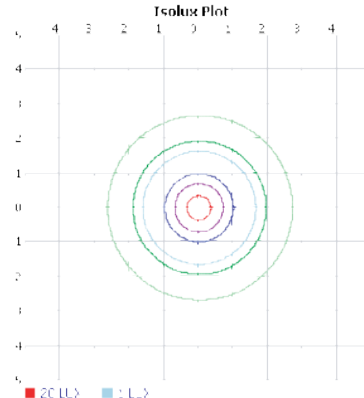
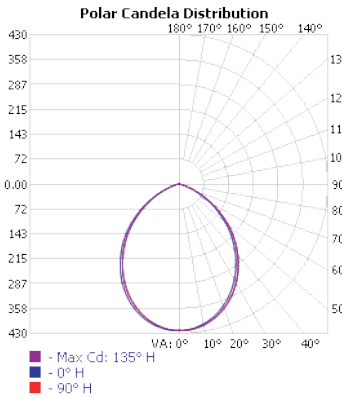

ZONAL LUMEN SUMMARY			
ZONE	LUMENS	% LAMP	% LUMINAIRE
0-30	312.9	35.8%	35.8%
0-40	494.4	56.6%	56.6%
0-60	788.3	90.3%	90.3%
60-90	84.9	9.7%	9.7%
70-100	19.7	2.3%	2.3%
90-120	0.000	0%	0%
0-90	873.1	100%	100%
90-180	0.000	0%	0%
0-180	873.1	100%	100%

LUMENS PER ZONE					
ZONE	LUMENS	% TOTAL	ZONE	LUMENS	% TOTAL
0-10	39.7	4.5%	90-100	0.000	0%
10-20	111.4	12.8%	100-110	0.000	0%
20-30	161.8	18.5%	110-120	0.000	0%
30-40	181.5	20.8%	120-130	0.000	0%
40-50	168.7	19.3%	130-140	0.000	0%
50-60	125.1	14.3%	140-150	0.000	0%
60-70	65.2	7.5%	150-160	0.000	0%
70-80	17.6	2.0%	160-170	0.000	0%
80-90	2.1	0.2%	170-180	0.000	0%

### 5/6" Downlight Retrofit 12W

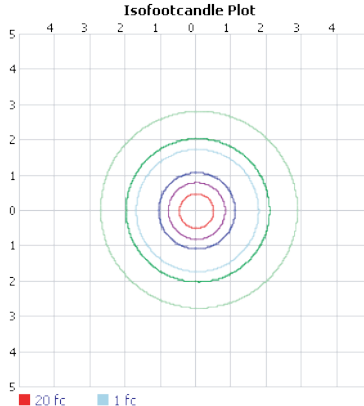
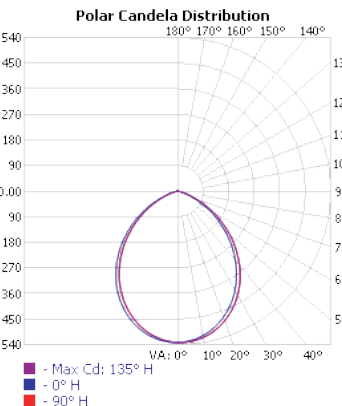

ZONAL LUMEN SUMMARY			
ZONE	LUMENS	% LAMP	% LUMINAIRE
0-30	396.5	35.8%	35.8%
0-40	627.6	56.7%	56.7%
0-60	1,000.3	90.3%	90.3%
60-90	106.9	9.7%	9.7%
70-100	24.2	2.2%	2.2%
90-120	0.000	0%	0%
0-90	1,107.2	100%	100%
90-180	0.000	0%	0%
0-180	1,107.2	100%	100%

LUMENS PER ZONE					
ZONE	LUMENS	% TOTAL	ZONE	LUMENS	% TOTAL
0-10	50.1	4.5%	90-100	0.000	0%
10-20	141.0	12.7%	100-110	0.000	0%
20-30	205.4	18.6%	110-120	0.000	0%
30-40	231.2	20.9%	120-130	0.000	0%
40-50	214.0	19.3%	130-140	0.000	0%
50-60	158.7	14.3%	140-150	0.000	0%
60-70	82.7	7.5%	150-160	0.000	0%
70-80	22.0	2.0%	160-170	0.000	0%
80-90	2.2	0.2%	170-180	0.000	0%